



# ZTT62

## USER GUIDE

SMART DIN RAIL MOUNTED ISOLATED TRANSMITTER  
INPUT THERMOCOUPLE  
TWO WIRE (4 to 20) mA



Important - Please read this document before any installing.

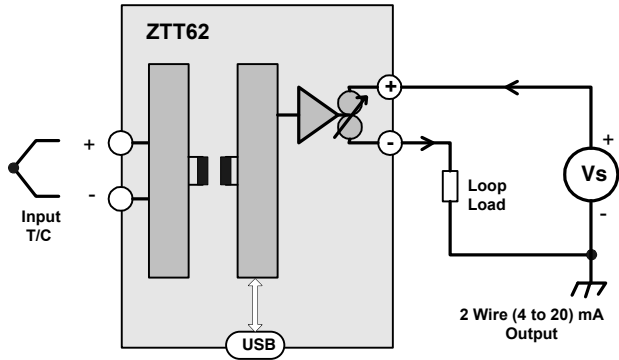

Every effort has been taken to ensure the accuracy of this document, however we do not accept responsibility for damage, injury, loss or expense resulting from errors and omissions, and we reserve the right of amendment without notice.



### IMPORTANT - CE & SAFETY REQUIREMENTS

Product must be mounted inside a suitable enclosure providing environmental protection to IP65 or greater.

To maintain CE EMC requirements, input wires must be less than 30 metres.

The product contains no serviceable parts, or internal adjustments. No attempt must be made to repair this product. Faulty units must be returned to supplier for repair.

This product must be installed by a qualified person. All electrical wiring must be carried out in accordance with the appropriate regulations for the place of installation.

Before attempting any electrical connection work, please ensure all supplies are switched off.

ABSOLUTE MAXIMUM CONDITIONS (To exceed may cause damage to the unit) :-

Supply Voltage	± 30 V dc (Protected for over voltage and reverse connection)
Current with over voltage	± 100 mA
Input Voltage	± 3 V between any terminals
Ambient	Temperature (-30 to 70) °C Humidity (10 to 95) % RH (Non condensing)

## PRODUCT SPECIFICATION

Please refer to the product data sheet for full specification, available to download at [www.ascontecnologic.com](http://www.ascontecnologic.com)

## RECEIVE AND UNPACKING

Please inspect the packaging and instrument thoroughly for any signs of transit damage. If the instrument has been damaged, please notify your supplier immediately.

## CONFIGURATION



IMPORTANT - The ZTT62 can be configured whilst connected and powered, but a portable battery powered computer must be used to avoid the effects of ground loops.

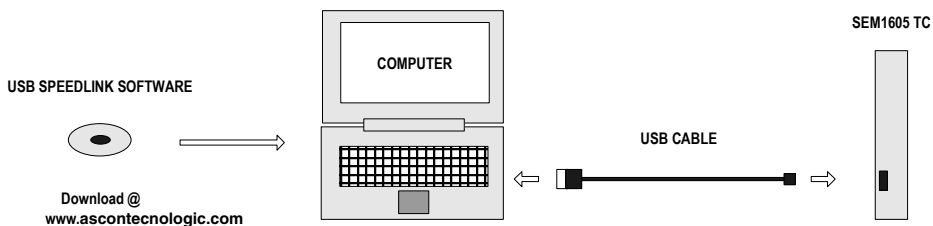

The following parameter can be configured by simply entering as prompted by the software package.

- Input type (K,J,E,N,T,R,S,L,U,B,C,D,G)
- Low range
- High range
- Units (°C, °F)
- Burnout (direction of output current on sensor burnout)

Factory default:  
 Input type = K  
 Low Range = 0  
 High Range = 1000  
 Units = °C  
 Burnout = UPSCALE

## MECHANICAL INSTALLATION

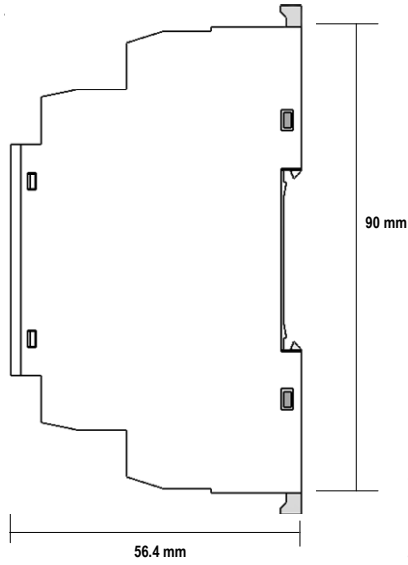

### MOUNTING

- 1 Screw driver



- 2 EN50022 DIN RAIL

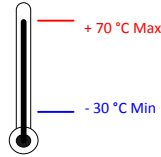
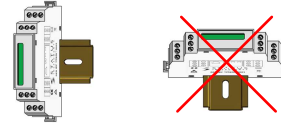

### ZTT62 Enclosure

Style	DIN 43880 (1 module width)
Material	Polyamide 6.6 self extinguishing
Terminals	Screw terminal
Cable	2.5 mm Max
Colour	Grey

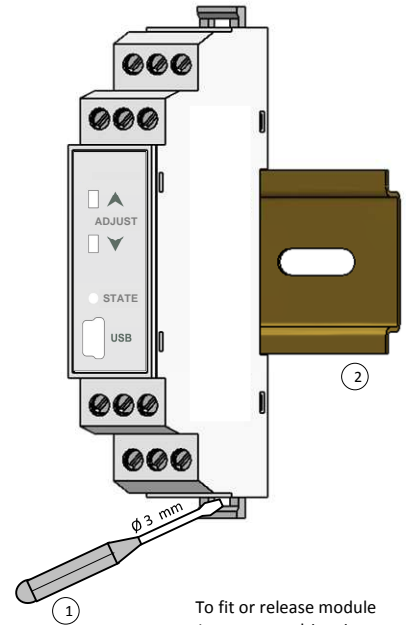

To fit or release module  
Insert screw driver into  
slot and lever latch  
away from body

## ELECTRICAL INSTALLATION

### Screened Cable



### Twisted Pair Cable



### TC Compensation Cable Screened



### Screw Driver



TURN OFF SUPPLY BEFORE WORKING ON ANY ELECTRICAL CONNECTION

### INPUT CONNECTION

Thermocouple inputs must use correct compensation cable.  
To maintain CE compliance cable length must be less than 30 metres.

### OUTPUT CONNECTION

Use twisted pair or screened cables for cable lengths greater than 30 metres. Max cable length 1000 metres. Ensure loop is grounded at one point.

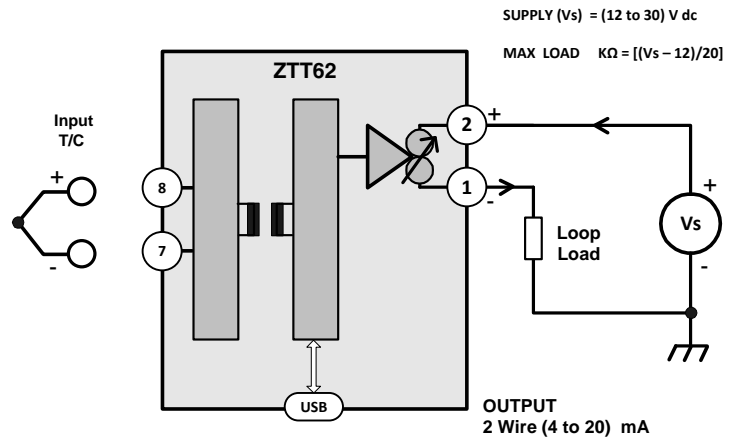

## Button Configuration options.

The ZTT62 has two options selectable in the USB Speed Link software, User Range and Off.

### USER RANGE

#### Screw Driver

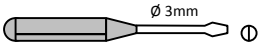

#### Power supply (12 to 30) Vdc

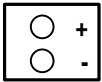

#### Thermocouple Simulator

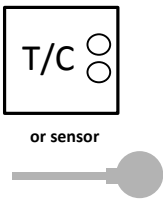

User range function allows manual adjustment of the 4 mA and 20 mA output range in relation to the input value.

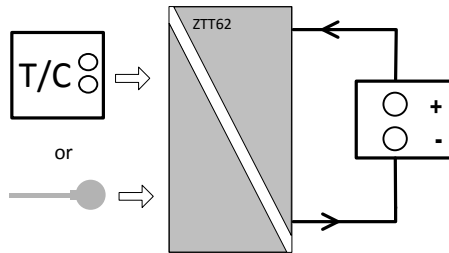

#### Method

1.0 Connect the thermocouple simulator or the input sensor to the ZTT62 using the two input connection terminals. Connect the ZTT62 to a (12 to 30) VDC power supply, a digital ammeter connected in series with the ZTT62 will be useful to monitor the (4 to 20) mA current but is not essential.

Turn on the supply and allow 1 minute warm up period.

2.0 Set the thermocouple simulator to the simulated temperature of the sensor for the required low range temperature, or apply required low range temperature to the sensor.

Allow 10 seconds for the ZTT62 to settle.

3.0 Press and hold the Low range ADJUST button, marked with a blue down arrow, until the STATE LED starts to flash, then release the button.

Press and release the Low range ADJUST button again, the STATE LED will flash quickly for a short time and the new low range will be stored. The output current will go to 4.0 mA.

4.0 Set the thermocouple simulator to the simulated temperature of the sensor for the required high range temperature, or apply required high range temperature to the sensor.

Allow 10 seconds for the ZTT62 to settle.

5.0 Press and hold the High range ADJUST button, marked with a Red up arrow, until the STATE LED starts to flash, then release the button.

Press and release the High range ADJUST button again, the STATE LED will flash quickly for a short time and the new high range will be stored. The output current will go to 20.0 mA. The ranging of the ZTT62 is now complete.

Note:- The Low and High user adjust can be set individually and in any order as required.

### OFF

Pressing the button has no action.

## Ascon Tecnologic s.r.l.

Viale Indipendenza 56, 27029 Vigevano (PV) - ITALY

Tel.: +39 0381 69871/faX: +39 0381 698730

www.ascontecnologic.com

e-mail: info@ascontecnologic.com