**User's
Manual**

FX1000™

**Models FX1002/FX1004/FX1006/FX1008/
FX1010/FX1012**

**FX1000
First Step Guide**

vigilantplant.®

Contents

Safety Precautions.....	3
Handling Precautions of the FX.....	4
Handling Precautions of the External Storage Medium (CF Card).....	4
Checking the Contents of the Package.....	5
Style number, release number, and firmware version number of the FX.....	6
Protection of Environment.....	7
Conventions Used in This Manual.....	7
Introduction to Functions.....	8
Measured Items.....	8
Data Storage Function.....	8
Display Function.....	8
Other Functions.....	8
DAQSTANDARD for FX1000.....	8
FX System Configuration.....	9
Terminology.....	9
Names of Parts.....	10
FX1000 Workflow.....	11
Basic Operation.....	12
Panel Keys.....	12
Display.....	12
Display on the Status Display Section.....	13
Run Modes.....	14
Entering Values and Characters.....	15
Inserting/Removing a CF Card.....	16
Setting the Functions and Operations.....	18
Setting the Date/Time.....	18
Setting the Input Range.....	19
Setting the Temperature Measurement Channel, the Input Range, and the Tag.....	19
Setting the Flow Rate Measurement Channel, the Input Range, the Alarm, and Tag.....	22
Assigning Channels to Groups.....	23
Setting the Time Scale.....	24
Saving the Setup Data.....	25
Starting Memory Sampling.....	26
Stopping Memory Sampling.....	26
Switching the Trend Display, Digital Display, and Bar Graph Display.....	27
Writing the Message “START”.....	28
Monitoring the FX on a PC Browser (Ethernet) (/C7 Option).....	30
Displaying the Measured Data on DAQSTANDARD.....	33

Contents

FX1000 User's Manual (Electronic Manual: IM04L21B01-01EN)

- Chapter 1 Overview of Functions
- Chapter 2 Common Operations
- Chapter 3 Measurement Channels and Alarms
- Chapter 4 Switching Operation Screens
- Chapter 5 Operations for Changing the Displayed Contents
- Chapter 6 Saving and Loading Data
- Chapter 7 Customizing the Action Using the Event Action and Remote Control Functions (/R1 and /PM1 Options)
- Chapter 8 Using the Security Function
- Chapter 9 Computation and Report Functions (/M1, /PM1, and /PWR1 Options)
- Chapter 10 Troubleshooting
- Chapter 11 Calibration
- Chapter 12 Installing and Wiring
- Chapter 13 Specifications
- Chapter 14 Setup Items

FX1000 Communication Interface User's Manual (Electronic Manual: IM04L21B01-17EN)

- Chapter 1 Using the Ethernet Interface (/C7 Option)
- Chapter 2 Using the Serial Interface (/C2 and /C3 Options)
- Chapter 3 Commands
- Chapter 4 Responses
- Chapter 5 Status Reports
- Chapter 6 Specifications

Thank you for purchasing the FX1000 (hereafter referred to as "FX".) This manual describes the basic operating procedures of the FX. To ensure correct use, please read this manual and the manuals below thoroughly before beginning operation.

Paper Manual

Manual Title	Manual No.
FX1000 Safety Precautions and Installation Guide	IM 04L21B01-03EN
How to Use the CD Installing FXA120 DAQSTANDARD and Opening FX1000 Manuals	IM 04L21B01-66EN

Electronic Manuals Provided on the Accompanying CD

Manual Title	Manual No.
FX1000 User's Manual	IM 04L21B01-01EN
FX1000 First Step Guide	IM 04L21B01-02EN
FX1000 Safety Precautions and Installation Guide	IM 04L21B01-03EN
This is the same as the printed copy.	
FX1000 Communication Interface (/C2, /C3, and /C7)	IM 04L21B01-17EN

DAQSTANDARD Manuals

Manual Title	Manual No.
FXA120 DAQSTANDARD for FX1000 Data Viewer	IM 04L21B01-63EN
FXA120 DAQSTANDARD for FX1000 Hardware Configurator	IM 04L21B01-64EN
How to Use the CD Installing FXA120 DAQSTANDARD and Opening FX1000 Manuals	IM 04L21B01-66EN
This is the same as the printed copy.	

Notes

- The contents of this manual are subject to change without prior notice as a result of continuing improvements to the instrument's performance and functions.
- Every effort has been made in the preparation of this manual to ensure the accuracy of its contents. However, should you have any questions or find any errors, please contact your nearest YOKOGAWA dealer.
- Copying or reproducing all or any part of the contents of this manual without YOKOGAWA's permission is strictly prohibited.
- The TCP/IP software of this product and the document concerning the TCP/IP software have been developed/created by YOKOGAWA based on the BSD Networking Software, Release 1 that has been licensed from the Regents of the University of California.

Revisions

1st Edition:	November, 2011
2nd Edition:	September, 2012

Trademarks

- vigilantplant is registered trademarks of Yokogawa Electric Corporation.
- Microsoft and Windows are registered trademarks or trademarks of Microsoft Corporation in the United States and/or other countries.
- Adobe and Acrobat are registered trademarks or trademarks of Adobe Systems Incorporated.
- Company and product names that appear in this manual are registered trademarks or trademarks of their respective holders.
- The company and product names used in this manual are not accompanied by the registered trademark or trademark symbols (® and ™).

2nd Edition: September 2012 (YK)
All Rights Reserved, Copyright © 2011, Yokogawa Electric Corporation

Safety Precautions

- This instrument conforms to IEC safety class I (provided with terminal for protective grounding), Installation Category II, and EN61326-1 (EMC standard), Measurement Category II (CAT II)*.
 - * Measurement category II (CAT II) applies to measuring circuits connected to low voltage installation, and electrical instruments supplied with power from fixed equipment such as electric switchboards.
- This instrument is an EN61326-1 (EMC standard) class A instrument (for use in commercial, industrial, or business environments).
- The general safety precautions described here must be observed during all phases of operation. If the FX is used in a manner not described in this manual, the FX safety features may be impaired. Yokogawa Electric Corporation assumes no liability for the customer's failure to comply with these requirements.
- The FX is designed for indoor use.
- About This Manual**
 - Please pass this manual to the end user. We also ask you to store this manual in a safe place.
 - Read this manual thoroughly and have a clear understanding of the product before operation.
 - This manual explains the functions of the product. It does not guarantee that the product will suit a particular purpose of the user.
- Precautions Related to the Protection, Safety, and Alteration of the Product**

The following safety symbols are used on the product and in this manual.



"Handle with care." To avoid injury and damage to the instrument, the operator must refer to the explanation in the manual.



Protective ground terminal



Alternating current



Direct current

- For the protection and safe use of the product and the system in which this product is incorporated, be sure to follow the instructions and precautions on safety that are stated in this manual whenever you handle the product. Take special note that if you handle the product in a manner that violates these instructions, the protection functionality of the product may be damaged or impaired. In such cases, YOKOGAWA does not guarantee the quality, performance, function, and safety of product.
- When installing protection and/or safety circuits such as lightning protection devices and equipment for the product and control system or designing or installing separate protection and/or safety circuits for fool-proof design and fail-safe design of the processes and lines that use the product and the control system, the user should implement these using additional devices and equipment.
- If you are replacing parts or consumable items of the product, make sure to use parts specified by YOKOGAWA.
- This product is not designed or manufactured to be used in critical applications that directly affect or threaten human lives. Such applications include nuclear power equipment, devices using radioactivity, railway facilities, aviation equipment, air navigation facilities, aviation facilities, and medical equipment. If so used, it is the user's responsibility to include in the system additional equipment and devices that ensure personnel safety.
- Do not modify this product.

WARNING

- **Use the Correct Power Supply**
Ensure that the source voltage matches the voltage of the power supply before turning ON the power.
- **Connect the Protective Grounding Terminal**
Make sure to connect the protective grounding to prevent electric shock before turning ON the power.
- **Do Not Impair the Protective Grounding**
Never cut off the internal or external protective grounding wire or disconnect the wiring of the protective grounding terminal. Doing so invalidates the protective functions of the instrument and poses a potential shock hazard.
- **Do Not Operate with Defective Protective Grounding**
Do not operate the instrument if the protective grounding might be defective. Also, make sure to check them before operation.
- **Do Not Operate in an Explosive Atmosphere**
Do not operate the instrument in the presence of flammable liquids or vapors. Operation in such an environment constitutes a safety hazard.
Prolonged use in a highly dense corrosive gas (H₂S, SO_x, etc.) will cause a malfunction.
- **Do Not Remove Covers**
The cover should be removed by YOKOGAWA's qualified personnel only. Opening the cover is dangerous, because some areas inside the instrument have high voltages.
- **Ground the Instrument before Making External Connections**
Connect the protective grounding before connecting to the item under measurement or control unit.
- **Damage to the Protection**
Operating the instrument in a manner not described in this manual may damage the instrument's protection.

CAUTION

This instrument is a Class A product. Operation of this instrument in a residential area may cause radio interference, in which case the user is required to take appropriate measures to correct the interference.

- **Exemption from Responsibility**
 - YOKOGAWA makes no warranties regarding the product except those stated in the WARRANTY that is provided separately.
 - YOKOGAWA assumes no liability to any party for any loss or damage, direct or indirect, caused by the user or any unpredictable defect of the product.
- **Handling Precautions of the Software**
 - YOKOGAWA makes no warranties regarding the software accompanying this product except those stated in the WARRANTY that is provided separately.
 - Use the software on a single PC.
 - You must purchase another copy of the software, if you are to use the software on another PC.
 - Copying the software for any purposes other than backup is strictly prohibited.
 - Please store the original media containing the software in a safe place.
 - Reverse engineering, such as decompiling of the software, is strictly prohibited.
 - No portion of the software supplied by YOKOGAWA may be transferred, exchanged, or sublet or leased for use by any third party without prior permission by YOKOGAWA.

Handling Precautions of the FX

- Use care when cleaning this instrument, especially its plastic parts. Use a soft dry cloth. Do not use organic solvents, such as benzene or thinner, or other cleansers. They may cause discoloring and deformation.
- Keep electrically charged objects away from the signal terminals. If you do, the FX may malfunction.
- Do not apply volatile chemicals to the display, panel keys, etc. Do not allow rubber and vinyl products to remain in contact with the FX for long periods of time. If you do, the FX may malfunction.
- When not in use, make sure to turn OFF the power switch.
- If there are any symptoms of trouble such as strange odors or smoke coming from the FX, immediately turn OFF the power switch and the power supply source. Then, contact your nearest YOKOGAWA dealer.

Handling Precautions of the External Storage Medium (CF Card)

- Use caution in the handling of the external storage medium as it is a delicate product.
- Write operation to storage media may fail under high-temperature or low-temperature environments. If you are using the FX in a low-temperature environment (around 10 °C or less), use the FX after the warm-up time (at least 30 minutes) has elapsed. If you are using the FX under a high-temperature environment (around 40 °C or more), it is recommended that the external storage medium be inserted into the drive when saving the data and be removed after the data storage operation is finished.
- Remove the storage medium from the drive when turning the FX ON/OFF.
- Touching the compact flash section when static electricity is built up on the human body can lead to erroneous operation.
- For the general handling precautions of the external storage medium, see the instruction manual that came with the external storage medium.

CAUTION

- Do not access the storage medium in a place with vibrations or shock. The storage medium or drive may malfunction.
-
-

Checking the Contents of the Package

Unpack the box and check the contents before operating the instrument. If some of the contents are not correct or missing or if there is physical damage, contact the dealer from which you purchased them.

FX

A name plate is located on the top panel of the FX. Check that the model name and suffix code given on the name plate match those on your order.

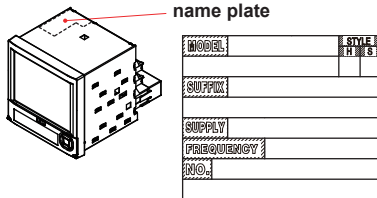

NO. (Instrument Number)

When contacting the dealer from which you purchased the instrument, please give them the instrument number.

Model and Suffix Codes

Model code	Suffix code	Optional code	Description
FX1002			2ch, Shortest measurement interval:125ms
FX1004			4ch, Shortest measurement interval:125ms
FX1006			6ch, Shortest measurement interval:1s
FX1008			8ch, Shortest measurement interval:1s
FX1010			10ch, Shortest measurement interval:1s
FX1012			12ch, Shortest measurement interval:1s
External storage medium slot	-0		Without CF card slot and medium ^(Note)
	-4		With CF card slot and medium
Language	-2		English/German/French/Italian/ Spanish/ Portuguese/ Russian/ Korean deg F and DST
Withstanding voltage between measuring input terminals	-H		1000 VAC(50/60 Hz), 1 min
	-L		400 VAC(50/60 Hz), 1 min
Options	/A1		Alarm output 2 points (C-contact) ¹
	/A2		Alarm output 4 points (C-contact) ¹
	/A3		Alarm output 6 points (C-contact) ^{1,3}
	/A4A		Alarm output 12 points (A-contact) ^{1,3}
	/C2		RS-232 interface ²
	/C3		RS-422A/485 interface ²
	/C7		Ethernet interface
	/F1		FAIL/Status output ³
	/M1		Mathematical functions (including Report functions)
	/N2		3 leg isolated RTD ⁴
	/N3F		Extended input type (without Pt1000)
	/P1		24 VDC/AC power supply
	/R1		Remote control 8 points ⁵
	/TPS2		24VDC transmitter power supply (2 loops) ⁶
	/TPS4		24VDC transmitter power supply (4 loops) ⁷
	/USB1		USB interface (1 port)
	/PM1		Pulse input 3 points, Remote control 5 points (including Mathematical functions) ⁸
/CC1		Calibration correction function	
/LG1		Log scale	
/PWR1		Power monitor (including Mathematical functions) ⁹	

Note: To load data, the FX must be equipped with a communication interface (/C2, /C3 or /C7 option) or the USB interface (/USB1 option.)

*1 Any combination of /A1, /A2, /A3, and /A4A cannot be specified together.

*2 /C2 and /C3 cannot be specified together.

*3 /A3 or /A4A cannot be specified together with /F1.

*4 /N2 cannot be specified for FX1002 or FX1004.

*5 If /R1 is specified, /A4A, /TPS2, /TPS4, /PM1, or /PWR1 cannot be specified.

*6 If /TPS2 is specified, /TPS4, /A2, /A3, /A4A, /F1, /R1, or /PM1 cannot be specified.

*7 If /TPS4 is specified, /TPS2, /A1, /A2, /A3, /A4A, /F1, /R1, or /PM1 cannot be specified.

*8 If /PM1 is specified, /A4A, /M1, /R1, /TPS2, /TPS4, or /PWR1 cannot be specified.

*9 If /PWR1 is specified, /A3, /A4A, /F1, /R1, /PM1, or /M1 cannot be specified.

*10 /TPS2, /PWR1, and /A1 cannot be specified together.

Standard Accessories

The standard accessories below are supplied with the instrument. Check that all contents are present and undamaged.

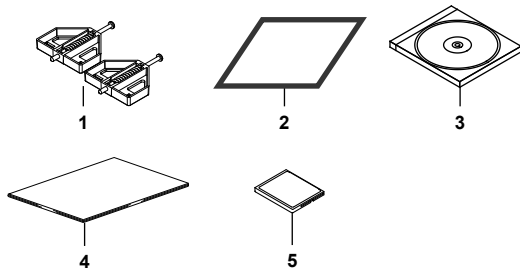

No.	Name	Model	Qty.	Notes
1	Mounting brackets	B8730BU	2	For panel mounting
2	Rubber packing for dust and water protection	-	1	For single-unit mounting
3	FX1000 DAQSTANDARD/Manuals	FXA120	1	CD. Contains the software and user's manuals.
4	FX1000 Safety Precautions and Installation Guide	IM 04L21B01-03EN	1	A3 size
	How to Use the CD	IM 04L21B01-66EN	1	A4 size
	Installing FXA120 DAQSTANDARD and Opening FX1000 Manuals			
5	CF card	772093	1	512 MB

*1 On FXs that have a CF card slot (suffix code -4.)
CF card capacity is subject to change.

Optional Accessories (Sold Separately)

The following optional accessories are available for purchase separately. If you make an order, make sure that all contents are present and undamaged. For information about ordering accessories, contact the dealer from which you purchased the FX.

No.	Name	Model	Q'ty	Notes
1	CF card	772093	1	512 MB
		772094	1	1 GB
		772095	1	2 GB
2	CF card adapter	772090	1	-
3	Shunt resistor	X010-250-3	1	250 Ω ± 0.1%
		X010-100-3	1	100 Ω ± 0.1%
		X010-010-3	1	10 Ω ± 0.1%
4	Mounting brackets	B8730BU	2	-
5	Terminal screws	B8730CZ	-	M3 (spares for I/O terminals)
		B8730CY	-	M4 (spares for power terminals)

Labels to Attach to the Front of the Operation Cover

You can attach a label to the front of the operation cover. The label is stored in an Excel file on the included CD. Print the label that you want to use.

The label is 19 ± 0.3 mm tall and 90 ± 0.3 mm wide.

Style number, release number, and firmware version number of the FX

Style number: This is the FX hardware number that is indicated on the name plate.

Release number: This is the FX firmware number that is indicated on the name plate. The number corresponds to the integer part of the firmware version number.

Example: If the firmware version number is 2.01, the release number is 2.

Firmware version number: This number is displayed on the FX system information screen. For the procedure, see section 2.5, "Viewing the FX Information" in the *FX1000 User's Manual, IM 04L21B01-01EN*.

MODEL	STYLE
SUFFIX	
SUPPLY	
PROCESOR	
NO.	

Release number
Style number

Protection of Environment

Control of Pollution Caused by the Product



For details, see the *FX1000 Safety Precautions and Installation Guide*, IM04L21B01-03EN.

Proper Disposal of This Product

This is an explanation of how to dispose of this product based on Waste Electrical and Electronic Equipment (WEEE), Directive 2002/96/EC. This directive is only valid in the EU.

- **Marking**

This product complies with the WEEE Directive (2002/96/EC) marking requirement.

The affixed product label (see below) indicates that you must not discard this electrical/electronic product in domestic household waste.



- **Product Category**

With reference to the equipment types in the WEEE directive Annex 1, this product is classified as a "Monitoring and Control instrumentation" product.

Do not dispose in domestic household waste.

To return unwanted products, contact your local Yokogawa Europe B. V. office.

Conventions Used in This Manual

- This manual covers information regarding FX1000 that have a suffix code for language "-2" (English).
- For details on how to set the language, see section 2.6, "Changing the Displayed Language" in the *FX1000 User's Manual*, IM 04L21B01-01EN.

Unit

K: Denotes 1024. Example: 768 KB (file size)

k: Denotes 1000.

The following markings are used in this manual.



Improper handling or use can lead to injury to the user or damage to the instrument. This symbol appears on the instrument to indicate that the user must refer to the user's manual for special instructions. The same symbol appears in the corresponding place in the user's manual to identify those instructions. In the manual, the symbol is used in conjunction with the word "WARNING" or "CAUTION."

WARNING

Calls attention to actions or conditions that could cause serious or fatal injury to the user, and precautions that can be taken to prevent such occurrences.

CAUTION

Calls attentions to actions or conditions that could cause light injury to the user or damage to the instrument or user's data, and precautions that can be taken to prevent such occurrences.

Note

Calls attention to information that is important for proper operation of the instrument.



Indicates after this mark reference to related procedure or explanation.

Bold characters

Indicates character strings that appear on the screen and the operation keys.

Introduction to Functions

Measured Items

You can connect DC voltage, thermocouple, RTD, and ON/OFF input and measure various values such as temperature and flow rate. The FX samples the input signals at the scan interval to obtain the measured values. The fastest scan interval is 125 ms on the FX1002 and FX1004, and 125 ms on the FX1006, FX1008, FX1010, and FX1012. Up to four alarm conditions can be set for each measurement channel.

Data Storage Function

There are two methods of recording measured data. One is to record the measured data continuously, and the other is to record only when certain events occur such as alarms. The measured data is recorded to the internal memory at a specified interval. The data in the internal memory can be stored to a CF card automatically or manually.

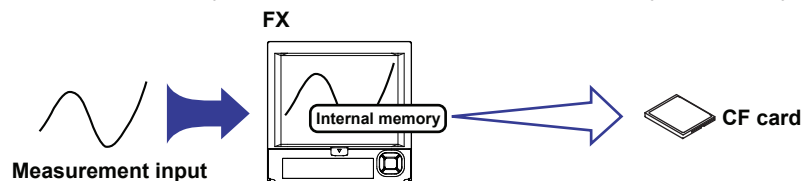

Display Function

Measured data can be displayed as trends, numeric values, and bar graphs for each group. In addition, the overview display can be used to display and monitor all channels on a single screen.

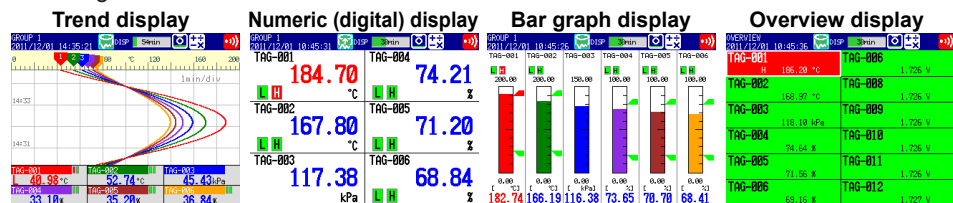

Other Functions

Mathematical Function (/M1, /PM1, and /PWR1 options)	Various types of computation can be performed by assigning equations to computation channels (Math channels.)
FAIL/status output function (/F1 option)	Outputs an alarm when the FX fails. The function also monitors the FX status such as the remaining amount of internal memory and outputs alarms.
Remote control function (/R1 option)	A specified action is executed when a remote input signal is applied to the terminal on the rear panel.
Security function	Enables only registered users can operate the FX. The function can also be used to prohibit key operation.
Communication function (/C2, /C3, and /C7 options)	The Ethernet interface can be used to monitor the FX using a Web browser and transmit e-mail when an event occurs such as an alarm. In addition, data of devices on the network can be loaded and displayed using the Modbus protocol.

DAQSTANDARD for FX1000

The accompanying software program, DAQSTANDARD for FX1000, can be used to display the measured data, convert the measured data format, and create FX setup data.

FX System Configuration

The FX can be used to configure a system as shown below.

Referenced sections are of the *FX1000 User's Manual (IM 04L21B01-01EN.)*

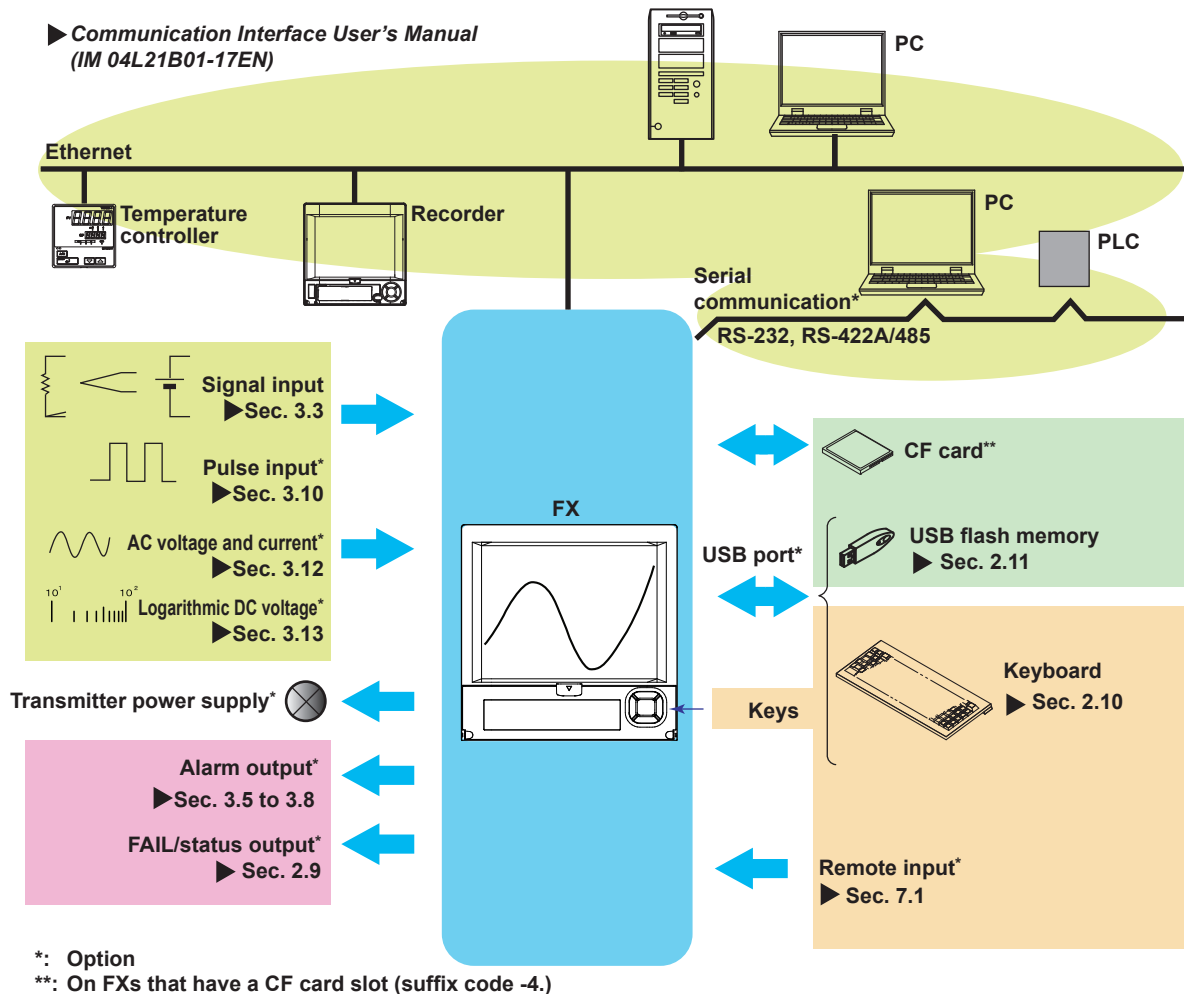

Terminology

- **Memory sample**
The operation of recording measured data.
- **Memory start**
The operation of starting memory sampling.
- **Memory stop**
The operation of stopping memory sampling.
- **Display data**
The waveform data shown on the FX display. The data recorded at the sampling interval for the displayed data.
- **Event data**
Measured data recorded at a sampling interval separate from that of the display data.
- **Manual sample**
The operation of recording measured data (instantaneous value) manually.

Names of Parts

Front View

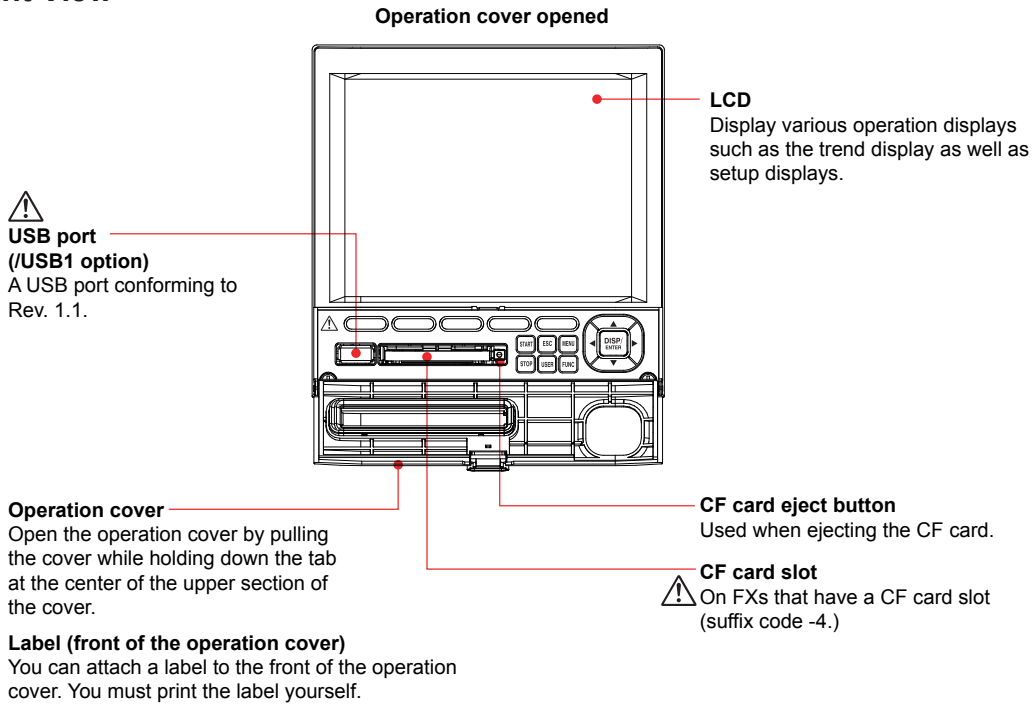

CAUTION

When closing the front cover, press the front cover in until the tab at the center of the upper section of the cover is all the way up. If the front cover is not closed completely, the water and dust proof capability may be impaired. If the rubber packing slipped, attach it so that the ribs come to the downside, as shown in the figure. The dust and water protection is not guaranteed if it is attached upside down. Attach it firmly, depressing the rib lightly with a finger.

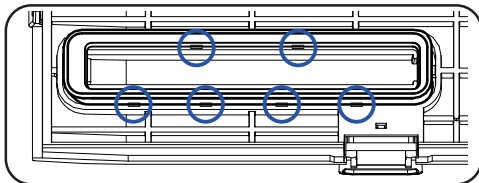

Rear Panel

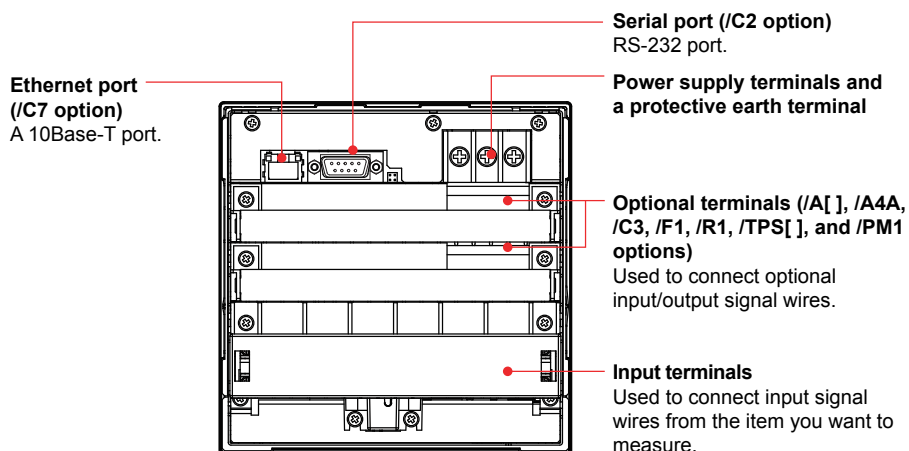

FX1000 Workflow

When using the FX for the first time, carry out the following procedure.

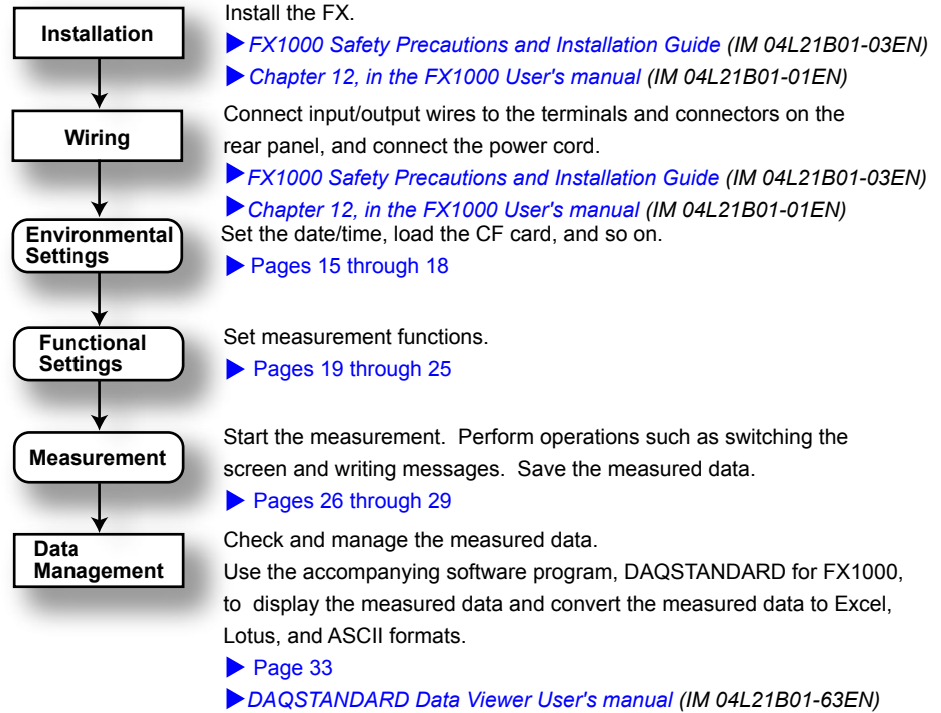

Basic Operation

Panel Keys

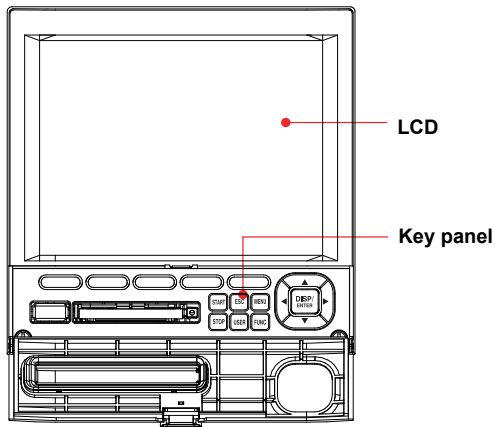

Soft keys
Selects the menu that is displayed at the bottom of the screen.

DISP/ENTER key and four arrow keys (up, down, left, and right)
Switches the operation screen.
Selects and enters setup items.

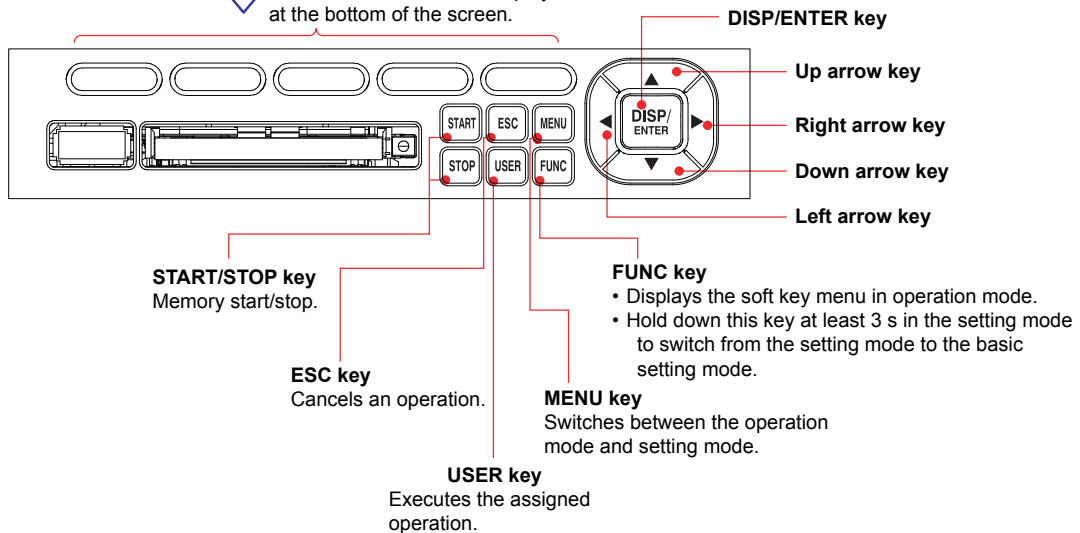

Display

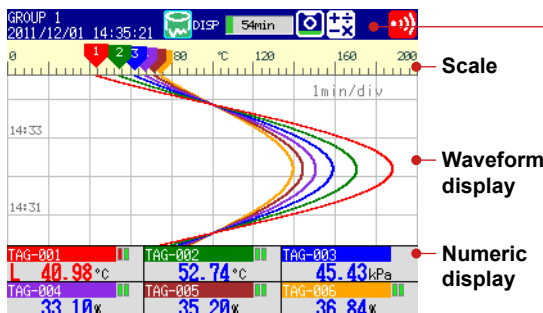

Status display section
Shows the display name, date/time, data recording, alarm icon, etc.

Data display section
Shows the measured data and the functional setup. For displaying the waveform and numeric display, see section 4.2, in the *FX1000 User's Manual, IM 04L21B01-01EN*. For the scale, see section 5.7, in the *FX1000 User's Manual, IM 04L21B01-01EN*.

Display on the Status Display Section

The following information is displayed in the status display section.

Memory sampling status

Memory sampling stopped

Memory sampling in progress

Memory sampling icon

Data type
 DISP: Display data
 EVENT: Event data

Memory sampling progress
 Displays the progress using a green bar graph. The frame indicates the file save interval (display data) or the data length (event data).

Error in internal memory.
 Contact your nearest YOKOGAWA dealer for repairs.

Displays the remaining memory sampling time for the left bar graph.

Display name or group name
 For all channel display on the trend display, "All" is displayed.

Date and time
 Displayed in yellow while the time is being corrected.

When using the batch function

AAA-1234-000541
 2011/12/01 14:21:25

Batch name and the display name are shown alternately.
Date and time

If the "batch number-lot number" exceeds 20 characters, the "date and time" position is used to display the "batch number-lot number."

When using the login function

Admin1
 2011/12/01 14:24:01

Name of the user logged in
Date and time and the display name are shown alternately.

When using the login and batch functions

Admin1
 AAA-1234-000542

Name of the user logged in
Batch name, the display name, and date and time are shown alternately.

Alarm icon

Displayed when any alarm is activated. Blinks when there are alarms that are occurring but have not been acknowledged. (Red)

All alarms have been released after they have occurred, but there are alarms that have not been acknowledged. (Green)

status icon

Keys are locked.

E-mail transmission (/C7 option) is enabled.

The status assigned to the status output (/F1 option) is occurring.

Computation icon (/M1, /PM1 or /PWR1 option)

White icon: Computation started.

Yellow icon: Computation data dropout occurred.

Red icon: Error in the power measurement section

CF card icon (On FXs that have a CF card slot)

CF card is being accessed.

Waiting.

Light blue icon: CF card in the slot is not recognized. Remove and reset it.

CF card error.
 Carry out the procedure below to reset the CF card icon to normal.

- Remove the CF card, and then reinsert it.
- Replace the CF card with a normal one.
- Format the CF card on the FX (the data on the CF card will be erased).

The green level display indicates the amount of CF card used. If Media FIFO* is not enabled and the free space on the CF card falls below 10%, the level indicator changes to red.

* See section 1.4, in the FX1000 User's Manual.

Run Modes

Mode Transition Diagram

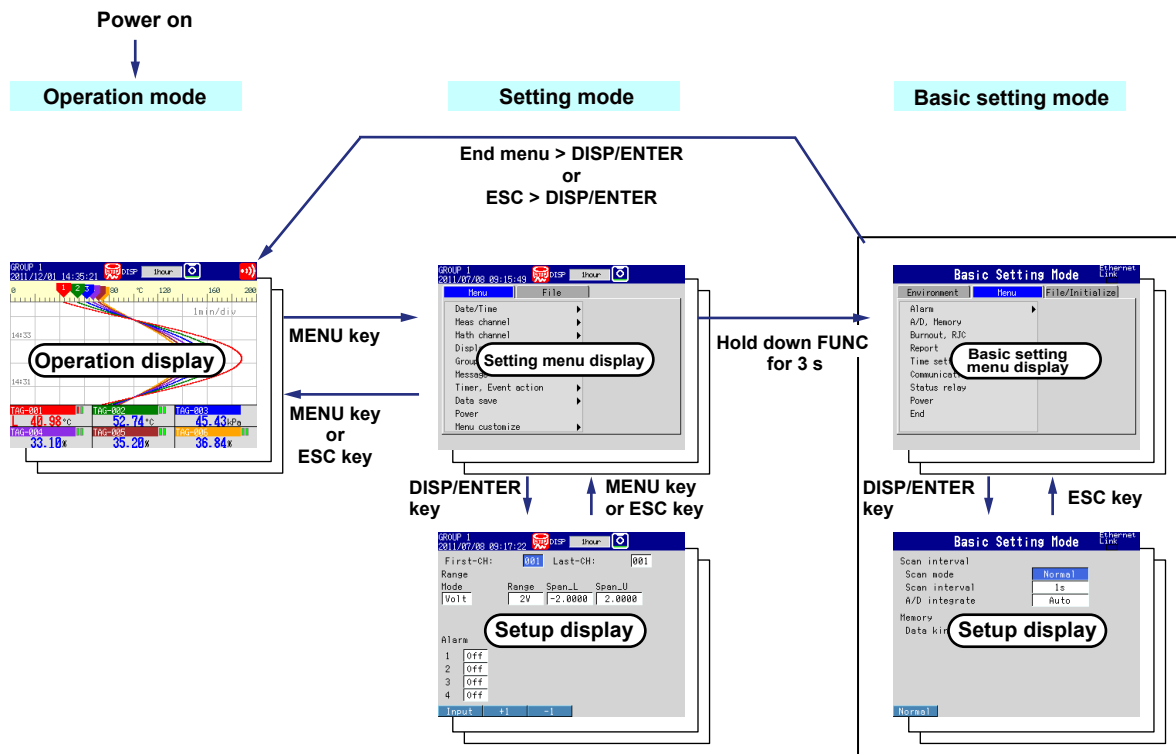

The FX has three modes.

Mode	Description
Operation mode	A mode for performing measurements.
Setting mode	A mode in which input range, measurement method, and so on are configured. Settings can be changed when memory sampling is in progress excluding some items.
Basic setting mode	A mode used to set basic items such as the scan interval and storage format of measured data. You cannot switch to this mode when memory sampling is in progress.

* For further details on the basic setting mode and setting mode, see Chapter 14, "Setup Items" in the *FX1000 User's Manual*, IM 04L21B01-01EN.

Entering Values and Characters

The character/number input window and DISP/ENTER key are used to set the date/time, set the display span of the input range, set the tag, set the message string, enter the password, etc.

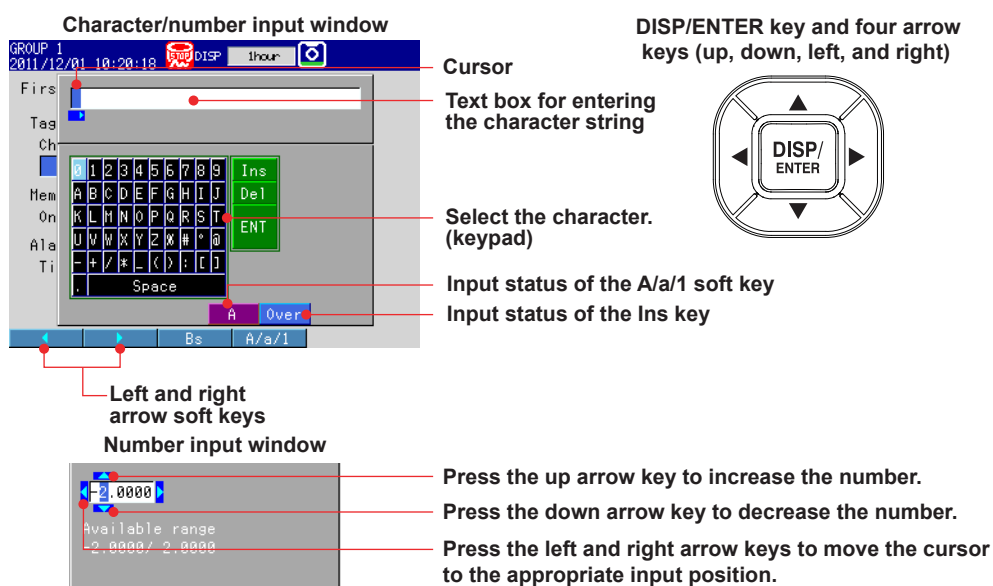

Entering Character Strings

When a window for entering a character string appears, enter it by performing the following key operation.

- **Left and right arrow soft keys:** Moves the cursor in the text box to select the input position.
- **Keypad:** Use the **four arrow keys (up, down, left, and right)** to move the cursor on the keypad to select the desired character.
 - Ins:** Switches between insert and overwrite.
 - Del:** Deletes the character at the cursor position in the text box.
 - ENT:** Enters the character string in the text box.
- **DISP/ENTER key:** Enter the character that you selected with the keypad in the text box or execute **Ins**, **Del**, or **ENT**.
- **Bs soft key:** Backspace. Deletes the character before the cursor.
- **A/a/1 soft key:** Selects uppercase alphabet (A), lowercase alphabet (a), or number (1).
The character type that you can enter changes each time you press the **A/a/1 soft key**. The selected character type is displayed at the bottom section of the character/number input window.

Inserting/Removing a CF Card

The following procedure is for FXs that have a CF card slot (suffix code -4.)

Inserting a CF Card

1. Open the front cover.



CAUTION

Forcing the CF card into the slot with the upside down may cause damage.

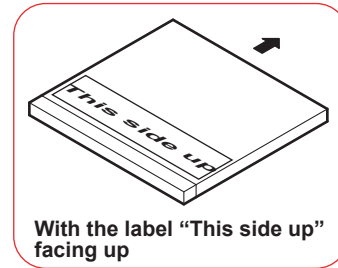
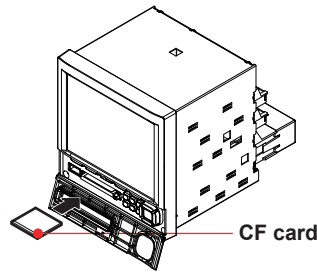

2. Insert the CF card into the slot.

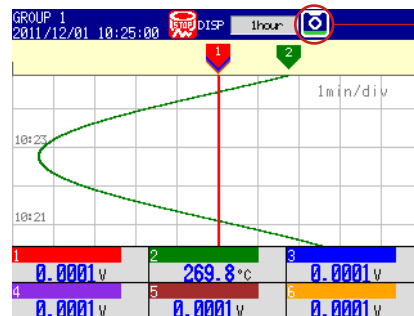

Displays the CF card icon
If the FX does not recognize the CF card, try reinserting it.

3. Close the front cover.

Operation complete.

Removing a CF Card

<Operations in the Operation Mode>

1. Open the front cover.
2. Press **FUNC** once.
3. Press the **Media eject** soft key once.

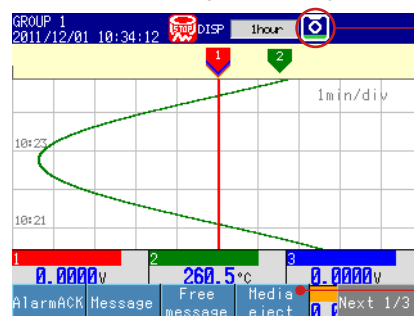

CF card icon

Media eject

4. Press the **CF** soft key once. The message "Media can be removed safely" appears. Displays the CF card icon in blue.

5. Press the CF card eject button. When you eject the CF card, the CF card icon disappears.

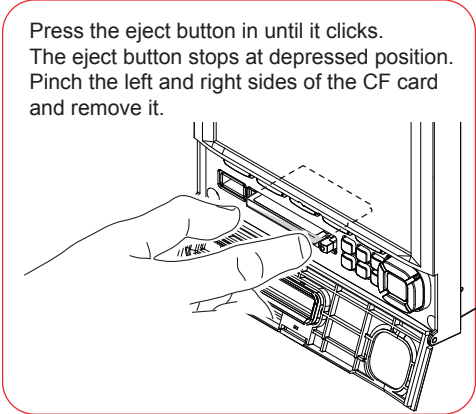
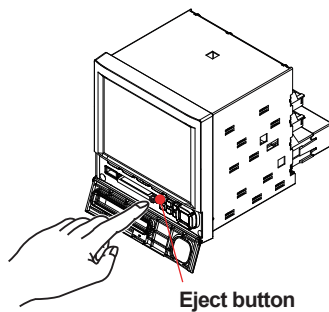

Press the eject button in until it clicks.
The eject button stops at depressed position.
Pinch the left and right sides of the CF card
and remove it.

6. Close the front cover.
Operation complete.

Setting the Functions and Operations

The contents of the screens used in the explanations in the following operation example may vary depending on the installed options and the FX settings.

Setting the Date/Time

In this example, we will change the date from the 1st to the 6th. After carrying out this step, reset the time to the correct date/time.

1. Display the operation mode screen.

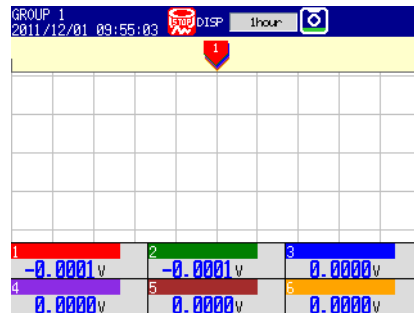

2. Press **MENU** once to display the setting menu.
3. Press the **down arrow key** once.
The cursor moves to **Date/Time**.
4. Press the **right arrow key** once.

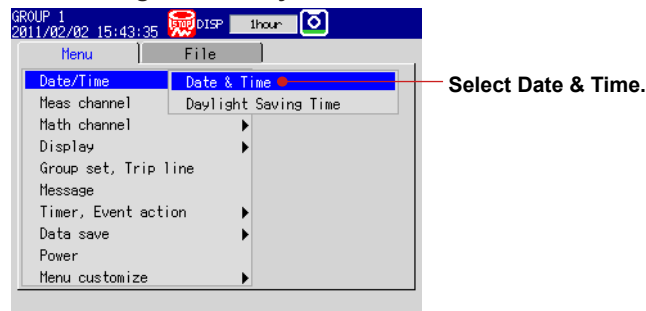

5. Press **DISP/ENTER** once to open the **Time set** window.
6. Change the date from 01 to 06.

Select the input position: Press the **right arrow key** five times to move the cursor in the text box.

Enter the value: Press the **up or down arrow key** several times to display 6.

Enter the input: Press **DISP/ENTER** once.

Cancel the setting: Press **ESC** before pressing **DISP/ENTER** (entering the input).

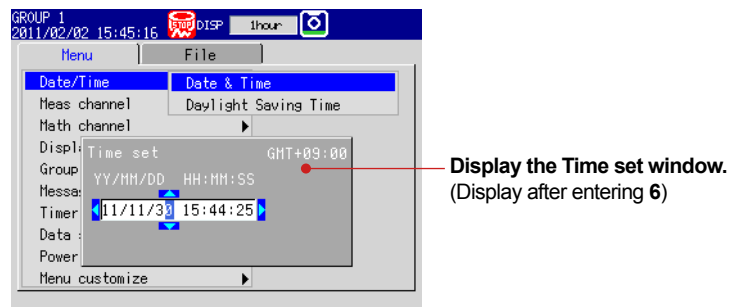

7. Press **ESC** twice or **MENU** once to return to the operation mode screen.

Operation complete.

Setting the Input Range

Configure the FX so that it measures temperature on measurement channel 1 and flow rate on measurement channel 2.

Setting the Temperature Measurement Channel, the Input Range, and the Tag

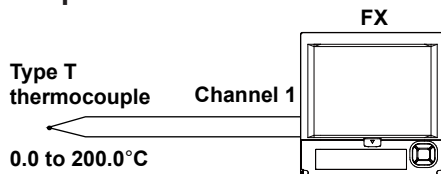

Setup Item	Description	Number in the Figure
Channel	Use channel 1.	1
Tag	TI-001	2
Sensor	Type T thermocouple	3
Input range	0.0 to 200.0°C	4

(1) Input Range

Press **MENU** (switch to the setting mode).

Select the **Menu** tab > **Meas channel** > **Range, Alarm**.

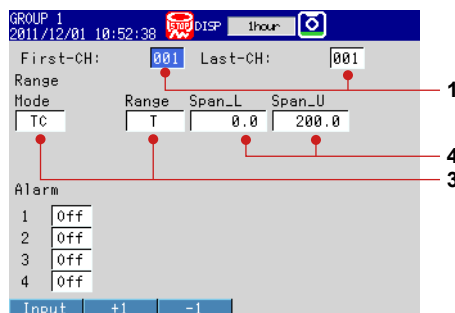

Setting Procedure

1. Display the operation mode screen.

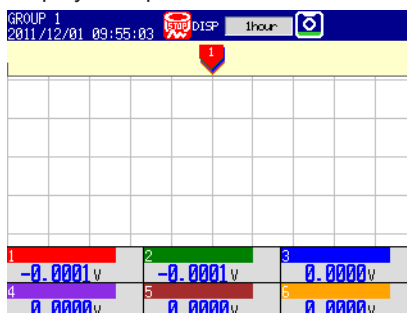

2. Press **MENU** once to display the setting menu.
3. Press the **down arrow key** twice to select **Meas channel**.
4. Press the **right arrow key** once.

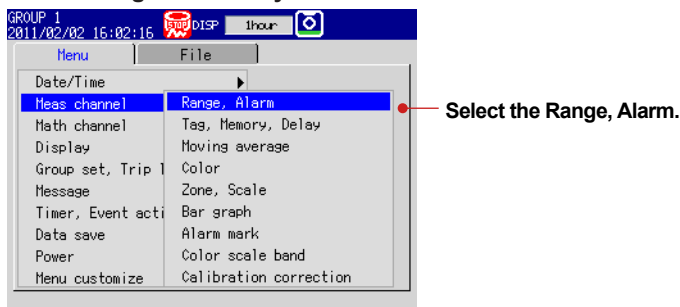

5. Press **DISP/ENTER** once.

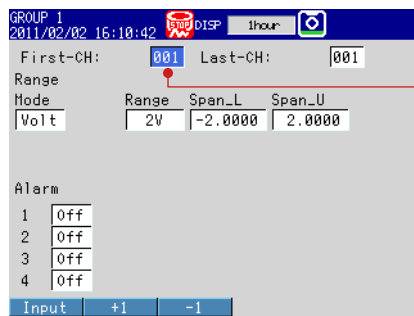

Select First-CH.

6. 001 is displayed next to **First-CH**, so do not change this setting.

Press the **+1** soft key once to set **First-CH** and **Last-CH** to 002.

7. Press the **down arrow key** once to move the cursor to **Mode**.

8. Press the **TC** soft key once. The cursor moves to **Range**, and the changed item is displayed in yellow.

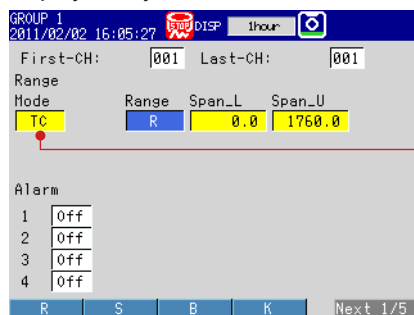

Select TC.

9. Press the **Next** soft key.

10. Press the **T** soft key once. The cursor moves to **Span_L**.

11. Press the **Input** soft key once.

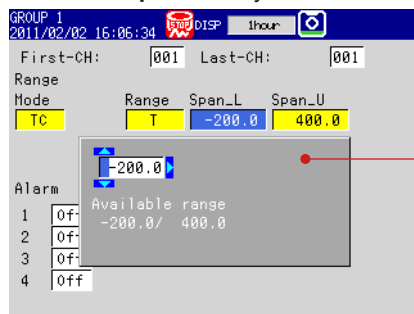

Display the Span_L setting window.

12. Enter 0.0 in the Span Lower box.

Select the input position: Press the **right arrow key** once to move the cursor in the text box to the right.

Delete the minus sign: Press the **up arrow key** once to delete the minus sign.

Delete the 2 and 0 in the same way.

Enter the input: Press **DISP/ENTER** once. **Span_L** is set, and the cursor moves to **Span_U**.

Cancel the setting: Press **ESC** before pressing **DISP/ENTER** (entering the input).

13. Enter 200.0 in the Span Upper box.

See step 12 for the procedure.

14. Press **DISP/ENTER** once. The changed items are entered, and the cursor returns to **First-CH**. The changed items change from yellow to white.

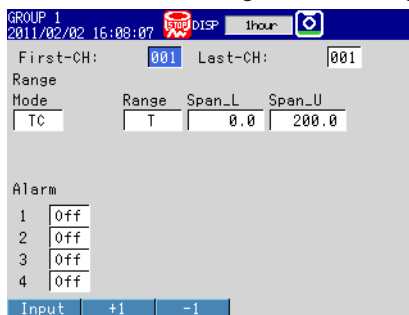

15. Press **ESC** three times or **MENU** twice to return to the operation mode screen.
Operation complete.

The following setup example shows only the procedure to display the appropriate screen and the screen after the settings have been configured.

(2) Tag

Select the **Menu** tab > **Meas channel** > **Tag, Memory, Delay**.

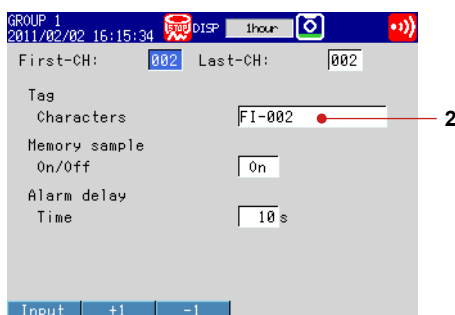

Operation complete.

For more details of the setting input range, see Section 3.3 “Setting the Input Range”, in the *FX1000 User’s Manual*, IM 04L21B01-01EN.

For more details of the setting tags, see Section 5.2 “Displaying Tags or Channel Numbers”, in the *FX1000 User’s Manual*, IM 04L21B01-01EN.

For more details of the displaying scale, see Section 5.7 “Displaying a Scale on the Trend Display”, in the *FX1000 User’s Manual*, IM 04L21B01-01EN.

Setting the Flow Rate Measurement Channel, the Input Range, the Alarm, and Tag

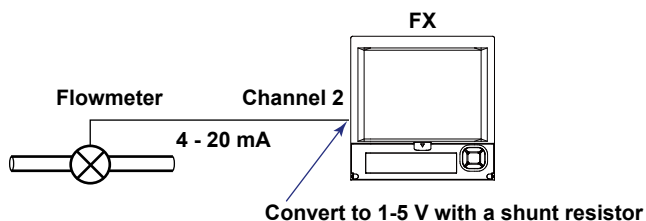

Setup Item	Description	Number in the Figure
Channel	Use channel 2.	1
Tag	FI-002	2
Input signal	1-5V	3
Input range	0.0 to 500.0 L/H	4
Alarm condition	Output an alarm if the measured value is less than or equal to 120.0 L/H. Output destination: Relay contact (I03)	5

(1) Input Range and Alarm

Press **MENU** (switch to the setting mode).

Select the **Menu** tab > **Meas channel** > **Range, Alarm**.

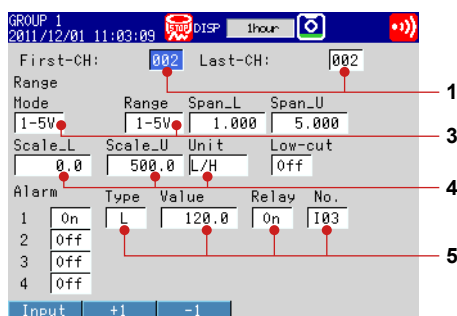

(2) Tag

Select the **Menu** tab > **Meas channel** > **Tag, Memory, Delay**.

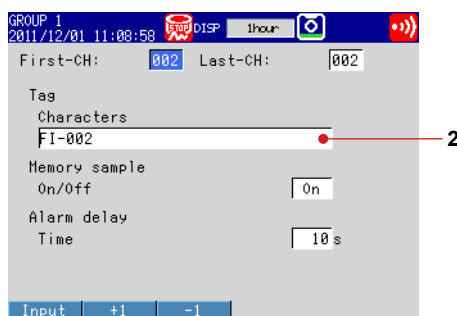

Operation complete.

For more details of the setting alarm, see Section 3.7 “Setting Alarms on Channels”, in the *FX1000 User’s Manual*, IM 04L21B01-01EN.

Assigning Channels to Groups

In this example, we will assign channels 1 and 2 to group 1.

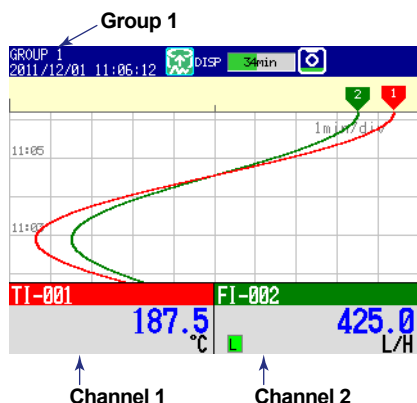

Setup Item	Description	Number in the Figure
Group	Assign channel 1 and 2 to group 1.	1

(1) Group

Press **MENU** (to switch to setting mode) > select the **Menu** tab > **Group set, Trip line**.

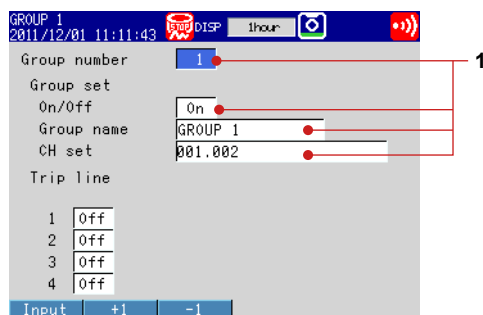

Operation complete.

For more details of the setting display group, see Section 5.1 “Setting Display Groups”, in the *FX1000 User’s Manual*, IM 04L21B01-01EN.

Setting the Time Scale

Set the time per division of the trend waveform to 2 minutes.

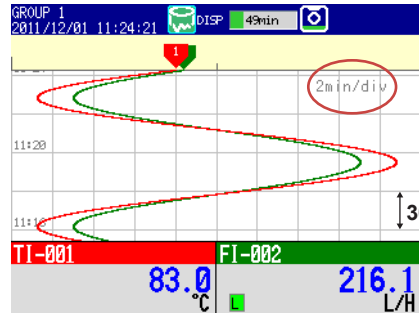

The sampling interval (the time corresponding to 1 dot) is 4 s when the trend interval is 2 min.
 $30 \text{ dots} \times 4 \text{ s} = 2 \text{ min}$

30 dots/div

Setup Item	Description	Number in the Figure
Trend interval	Set the time per division to 2 minutes. The waveform is updated at every 4 s.	1

(1) Trend interval

Press **MENU** (to switch to setting mode) > select the **Menu** tab > **Display** > **Trend/Save interval**.

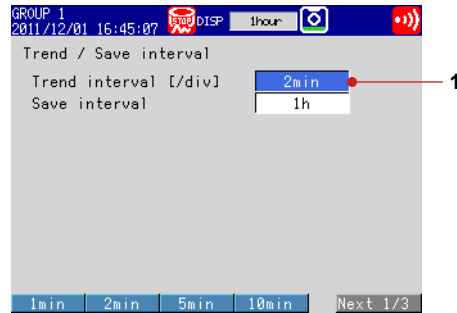

Operation complete.

For more details of the setting trend interval, see Section 6.1 “Setting the Recording Conditions of the Measured Data”, in the *FX1000 User's Manual*, IM 04L21B01-01EN.

If you start memory sampling after configuring the settings as shown above, the measured values are displayed as a waveform (trend display) and are recorded to the internal memory. The data recorded to internal memory is separated into files. Each file contains one hour's worth of data. To change the file size, see Section 6.1 “Setting the Recording Conditions of the Measured Data”, in the *FX1000 User's Manual*, IM 04L21B01-01EN.

On FXs that have a CF card slot, if a CF card has been inserted in the slot, files are saved automatically to the "DATA0" folder on the CF card. To change how data is saved to the CF card, see Section 6.2 “Setting the Method for Saving the Data”, in the *FX1000 User's Manual*, IM04L21B01-01EN.

If you want to save setup data on an FX that has a CF card slot, follow the procedure under "Saving the Setup Data" on the next page.

Saving the Setup Data

The following procedure is for FXs that have a CF card slot (suffix code -4.)
In this example, we will save the setup data to a file named "SF2" on the CF card.

1. Display the operation mode screen.

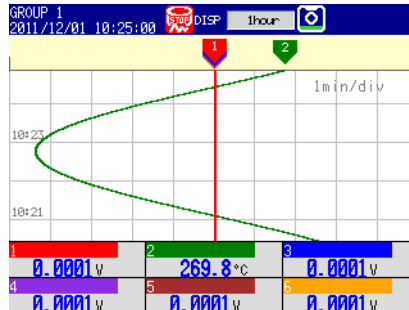

2. Press **MENU** once to display the setting menu.
3. Press the **right arrow key** once to select the **File** tab.
4. Press the **down arrow key** four times.

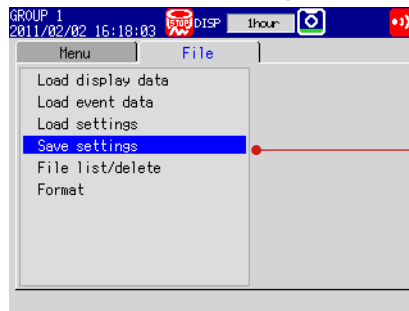

Select Save settings.

5. Press **DISP/ENTER** once.
6. Press the **Input** soft key once.
7. Enter "SF2" for the file name.
For the input procedure, see "Entering Values and Characters" on page 15.

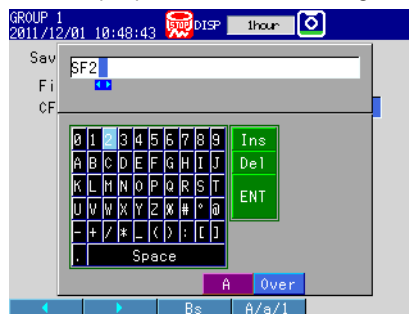

8. Press **DISP/ENTER** once. The message "Data are being saved to media" appears, and the setup data is saved.
9. Press **ESC** or **MENU** twice to return to the operation mode screen.

Operation complete.

Starting Memory Sampling

1. Press **START** once.

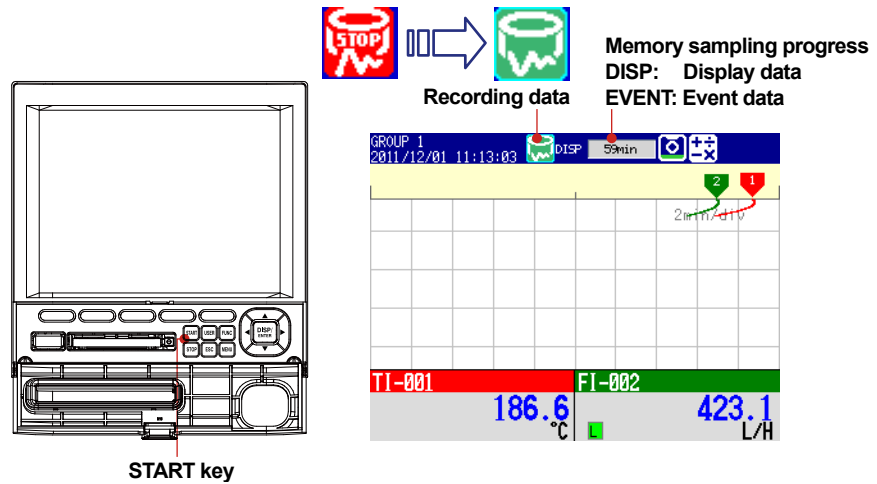

Operation complete.

Stopping Memory Sampling

1. Press **STOP** once.

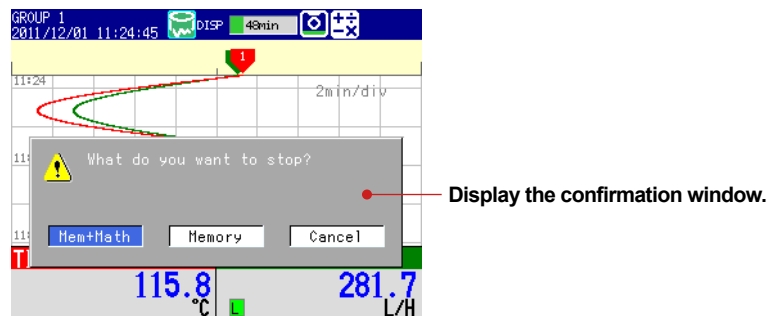

2. Select **Mem+Math** or **Memory** using the left and right arrow keys.
Memory: Stops memory sampling.
Mem+Math: Stops memory sampling and computation (option).
 On models without the computation function (option), the confirmation message "Do you want to stop data storage?" appears. Select **Yes**.
3. Press **DISP/ENTER** once.



Operation complete.

Switching the Trend Display, Digital Display, and Bar Graph Display

1. Press **DISP/ENTER** once to show the display selection menu.

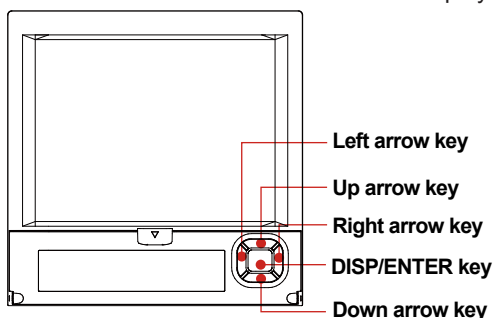

2. Press the **down arrow key** to select **TREND**, **DIGITAL**, or **BAR**.
3. Press the **right arrow key** once to display the sub menu. To close the sub menu that you opened, press the **left arrow key**.
4. Press the **down arrow key** to select the group.

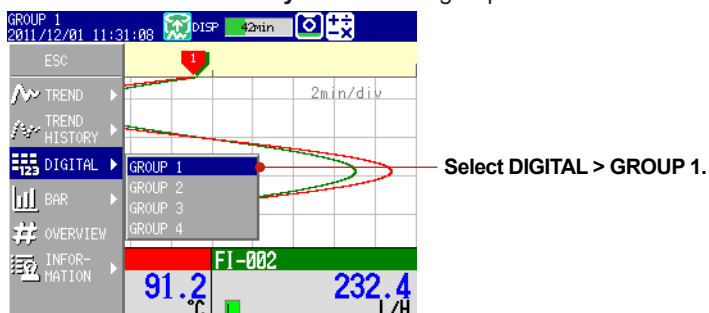

5. Press **DISP/ENTER** once to show the operation display of the selected group. To close the menu without switching the display, press **ESC**.

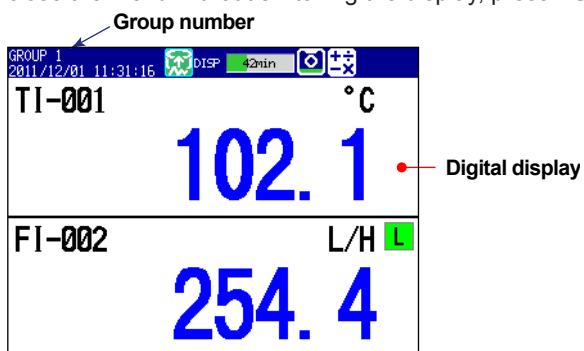

Operation complete.

Press the **down arrow key** when the trend, digital, or bar graph is displayed to switch the display in the order trend, digital, bar graph, trend, and so on. Press the **up arrow key** to switch the display in reverse order. Press the **right arrow key** or the **left arrow key** to switch the group.

For how to use the several display, see Section 1.3 Display and Chapter 4 "Switching Operation Screens", in the *FX1000 User's Manual*, IM 04L21B01-01EN.

Writing the Message “START”

Registering the Word “START” in Message Number 1

1. Press **MENU** (to switch to setting mode) > select the **Menu** tab > **Message** > **DISP/ENTER**.
2. Press the **1-10** soft key.
The message, “Message numbers 1-10 can also be used for free message” appears. Press **DISP/ENTER**.
3. Press the **down arrow key**. With **message 1** selected, press the **Input** soft key.
Enter “START”.

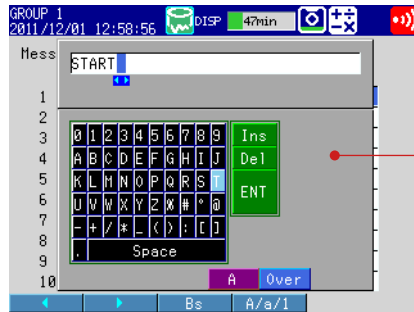

Show the message registration window.

For the input procedure, see “Entering Values and Characters” on page 15.

4. Press **DISP/ENTER**.

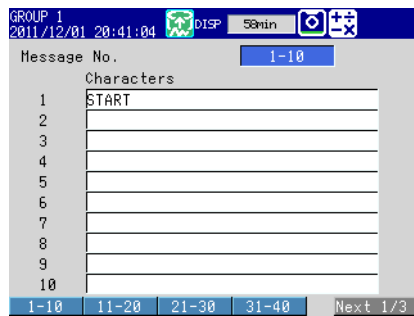

5. Press **ESC** three times or **MENU** twice to return to the operation mode screen.
Operation complete.

Writing Message Number 1 “START”

This operation can only be carried out while memory sampling is in progress. The message is displayed on the trend display. Show the trend display first.

1. Press **FUNC** (display the FUNC key menu), press the **Message** soft key, and press the **1-10** soft key.



Show the message registration window.

1 soft key

2. Press the 1 soft key.

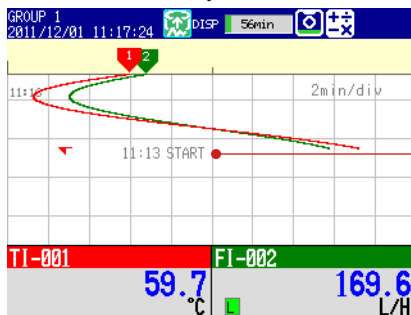

Shows the message.
(time, message, and message mark)
Also recorded to the internal memory.

Operation complete.

Monitoring the FX on a PC Browser (Ethernet) (/C7 Option)

In this example, we will connect the PC and the FX via hub in a one-to-one relationship and display and monitor the FX screen on a browser on the PC.

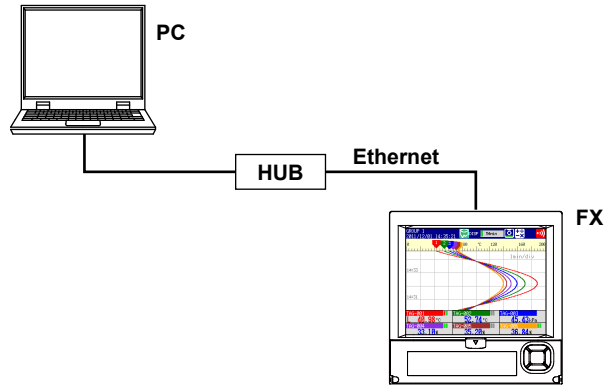

FX

Setup Item	Description	Number in the Figure
IP address	192.168.1.101	1
Subnet mask	255.255.255.0	
Web server function	Monitor from a Web browser on the PC using operator page.	2
Access to the FX	Display the Web page and do not set access privileges.	3

PC

Setup Item	Description	Number in the Figure
IP address	192.168.1.100	4
Subnet mask	255.255.255.0	

(1) IP Address of the FX

Press **MENU** (switch to the setting mode), hold down **FUNC** for 3 s (switch to the basic setting mode).

Select the **Menu** tab > **Communication (Ethernet)** > **IP-address**.

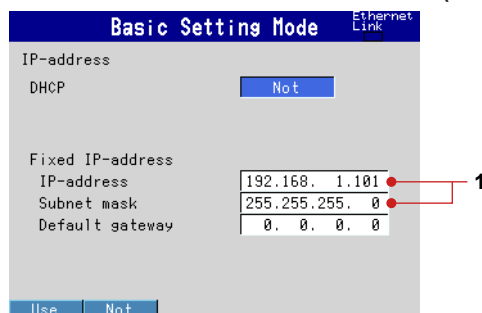

(2) Enabling the Web Server Function on the FX

Select the **Menu** tab > **Communication (Ethernet)** > **Server** > **Server modes**.

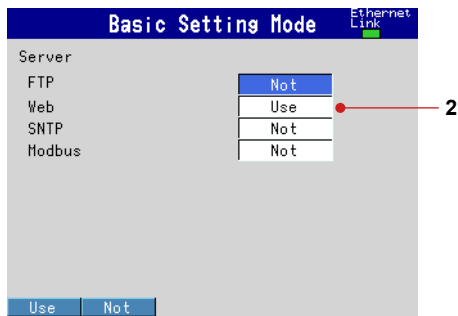

(3) Display the FX Screen on the PC

Select the **Menu** tab > **Communication (Ethernet)** > **Web page**.

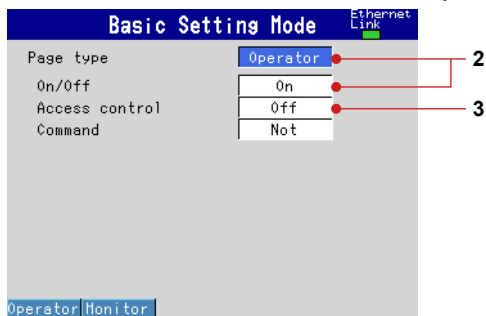

(4) Save the Settings

1. Press **ESC** twice to return to the basic setting menu.
2. Press **ESC** once more.
The window appears for you to confirm the saving of the settings.
3. Select **Yes** and press **DISP/ENTER**.
The FX returns to the operation mode screen.

(5) Setting the PC

Set the IP address and subnet mask on the PC.

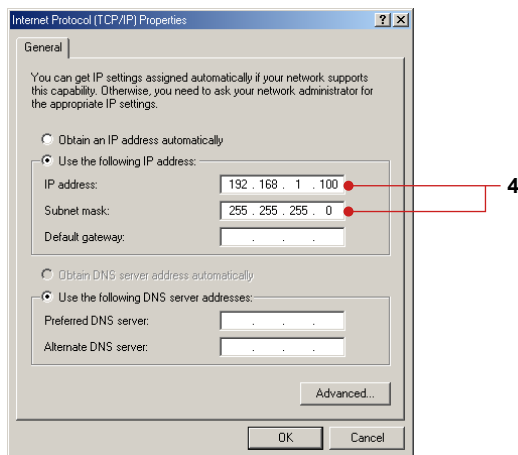

Monitoring the FX on a PC Browser (Ethernet) (Option /C7)

(6) Checking the Connection

Send the command below from the PC and check that a correct response is returned.

Send

```
>ping 192.168.1.101
```

Response example

```
>Reply from 192.168.1.101: bytes=32 time<10ms TTL=255
```

(7) Displaying the FX Screen on the Browser

1. Start the browser on the PC.
2. Enter the following URL.
`http://192.168.1.101/operator.htm`
3. Check that the FX screen appears.

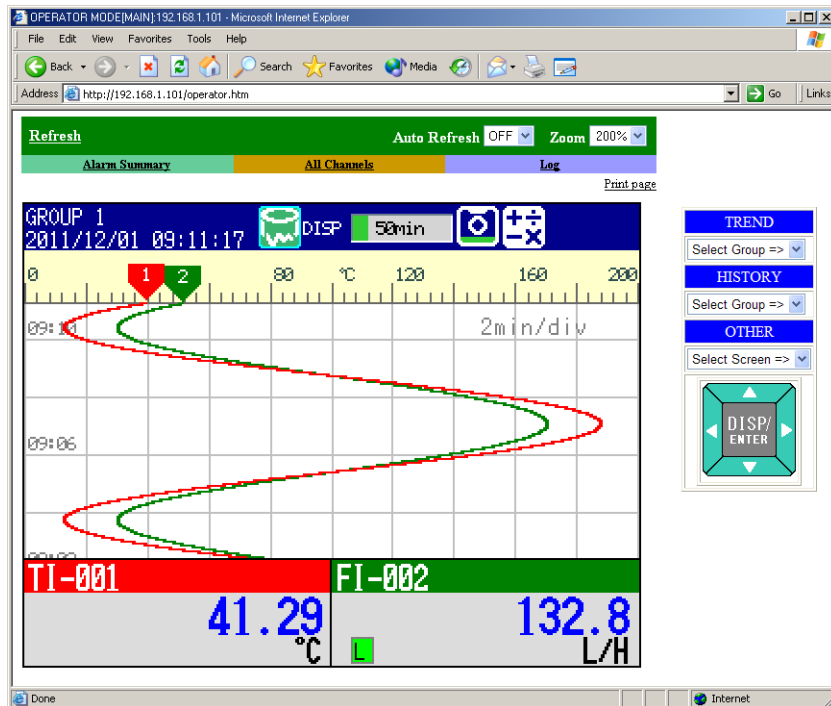

Operation complete.

Displaying the Measured Data on DAQSTANDARD

In this example, we will display the measured data using the accompanying software program, DAQSTANDARD.

1. Insert the CF card containing the measured data file into the PC that has DAQSTANDARD installed.
2. Start DAQSTANDARD Viewer.

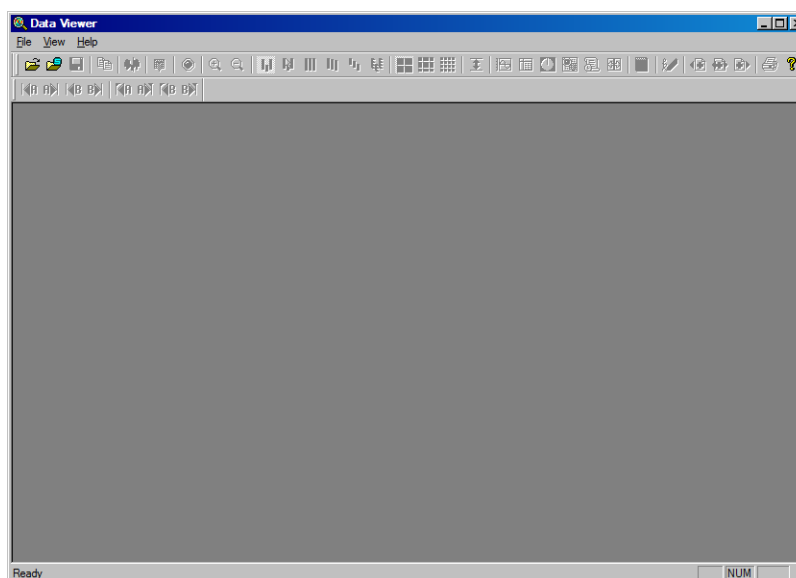

3. From the **File** menu, choose **Open**.
4. In the Open dialog box, select the desired file, and click **Open**.
The data is displayed.

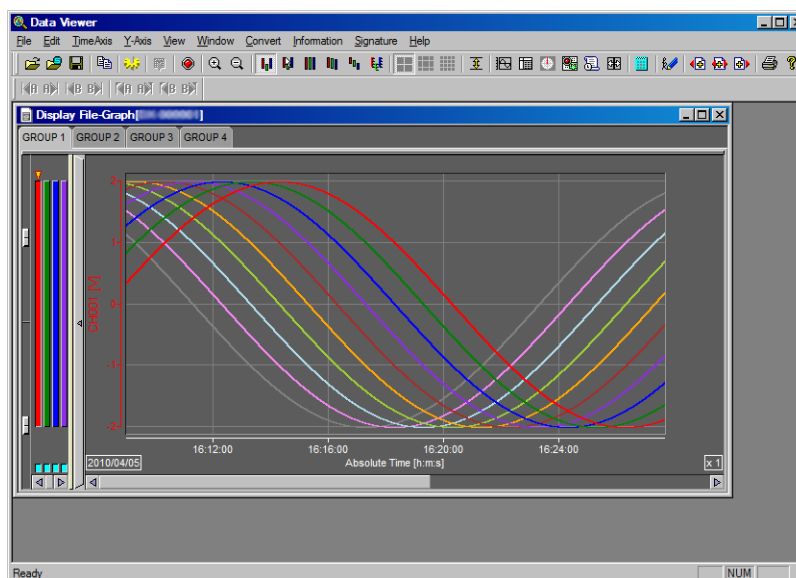

Operation complete.