

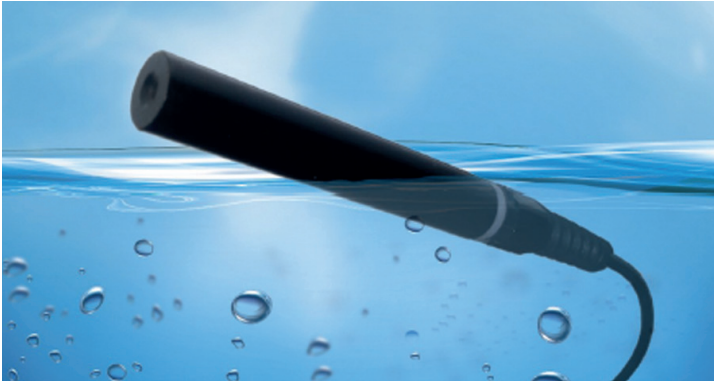

TRH324

RELATIVE HUMIDITY AND TEMPERATURE PROBE WITH 0 ÷ 10 V OUTPUT



User manual

22/10 - Code: ISTR_M_TRH324_E_01_--

ASCON TECNOLOGIC S.r.l.

Viale Indipendenza 56, 27029 - VIGEVANO (PV) ITALY
TEL.: +39 0381 69871 - FAX: +39 0381 698730
sito: <http://www.ascontecnologic.com>
e-mail: info@ascontecnologic.com

PREFACE

 This manual contains the information necessary for the product to be installed correctly and also instructions for its maintenance and use; we therefore recommend that the utmost attention is paid to the following instructions and to save it.

This document is the exclusive property of Ascon Technologic S.r.l. which forbids any reproduction and divulgation, even partially, of the document, unless expressly authorized.

Ascon Technologic S.r.l. reserves the right to make any formal or functional changes at any moment and without any notice.

Ascon Technologic S.r.l. and its legal representatives do not assume any responsibility for any damage to people, things or animals deriving from violation, wrong or improper use or in any case not in compliance with the instrument features.

 Whenever a failure or a malfunction of the device may cause dangerous situations for persons, thing or animals, please remember that the plant has to be equipped with additional devices which will guarantee safety.

1. INSTRUMENT DESCRIPTION

1.1 General description

The probes of the **TRH324** series are devices characterized by a very low energy consumption and with an external dissipative element in the case of the 2-wire versions.

These features allow an excellent measurement accuracy even in poor ventilation conditions. Moreover, the devices are built to have an excellent protection degree.

2. USAGE WARNINGS

2.1 Admitted usage

 The instrument has been projected and manufactured as a measuring and control device to be used according to EN60730-1 at altitudes operation below 2000 m.

Using the instrument for applications not expressly permitted by the above mentioned rule must adopt all the necessary protective measures.

The instrument **must not be used** in dangerous environments (flammable or explosive) without adequate protections.

 The installer must ensure that the EMC rules are respected, also after the instrument installation, if necessary using proper filters.

3. INSTALLATION WARNINGS

3.1 Mounting requirements

Select a mounting location having the following characteristics:

- It should be easily accessible;
- It must not be subjected to vibrations or impacts;
- Must be free from corrosive gases;
- Must be free from water or other fluids (condensation).

3.2 Installation position

Wall fixing is done by clips. Particular attention must be paid to the sensor positioning, it must be kept away from heat sources that can influence the measurements.

In the **TRH324** probe design, an attempt was made to limit, as much as possible, the sensor self-heating possibility, minimizing energy consumption and taking the dissipative element, necessary in the case of a 2-wire sensor, away from the sensor.

It is a good idea to mount the probe with the sensor facing downwards (output cable upwards) or, at least, horizontally, but **NEVER** with the sensor upwards to avoid possible measurement errors due to residual self-heating and to the condensation stagnation. With the anti-blinding container (conical sensor protection) mounting with the sensor downwards is mandatory.

In the case the sensor filter should be cleaned, the probe must be disassembled, then access the protective cap (which can be replaced). Avoid touching the humidity sensor and be careful not to lose the sealing o-rings.

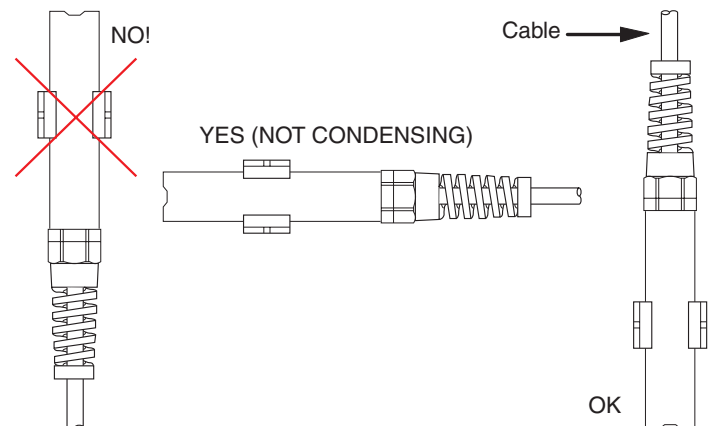

Any error in humidity measurement may be due to the settling time of the probe, in this case it will be necessary to wait for the time necessary to achieve a stable measurement.

Steam jets, water sprays, drafts, direct sun exposure, condensation on the sensor or mounting on a wall made cold by the outside temperature can also cause important measurement errors; due to these conditions, during the installation, the probe must be protected from any possible external influence.

3.3 Electrical Connections

General notes on electrical connections

- The probe cables must be kept separated from high power voltage wiring.

3.3.1 Electrical wiring

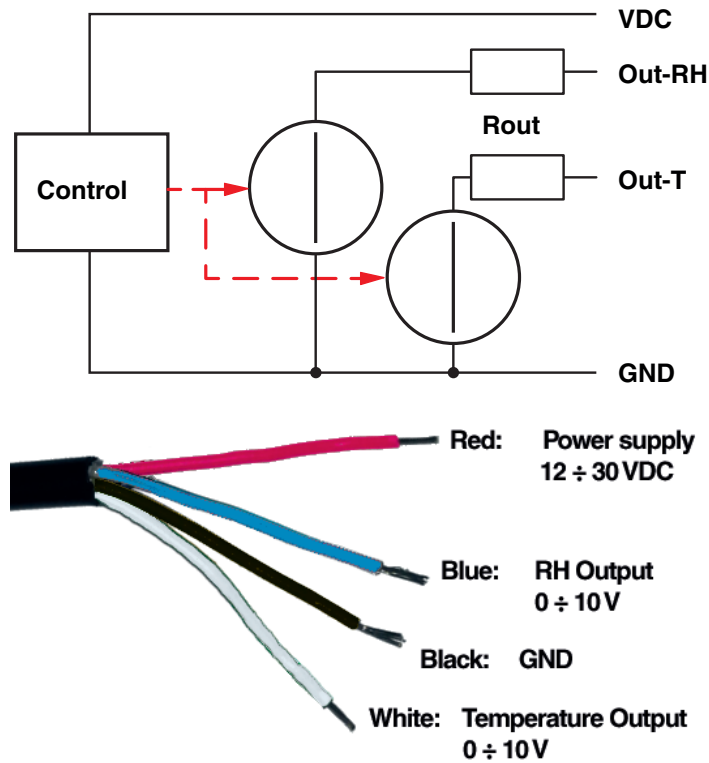

Power supply voltage: 12 ÷ 30 VDC;

Current consumption: < 10 mA + the output current;

Reverse polarity protection: Diode.

4. PROBLEMS AND MAINTENANCE

4.1 Cleaning

We recommend to clean the instrument with a slightly wet cloth using water and not abrasive cleaners or solvents only. Should it be necessary to remove the sensor, avoid to mechanical stress it and in particular avoid touching the humidity sensor.

4.2 Disposal



The appliance (or the product) must be disposed of separately in compliance with the local standards in force on waste disposal.

5. WARRANTY AND REPAIRS

The instrument is under warranty against manufacturing flaws or faulty material, that are found within 18 months from delivery date. The warranty is limited to repairs or to the replacement of the instrument.

The eventual opening of the housing, the violation of the instrument or the improper use and installation of the product will bring about the immediate withdrawal of the warranty effects.

In the event of a faulty instrument, either within the period of warranty, or further to its expiry, please contact our sales department to obtain authorisation for sending the instrument to our company.

The faulty product must be shipped to Ascon Tecnologic with a detailed description of the faults found, without any fees or charge for Ascon Tecnologic, except in the event of alternative agreements.

6. TECHNICAL DATA

6.1 Sensor characteristics

Sensor type: CMOS-C.

6.1.1 Relative humidity

Parameter	Condition	Min.	Typical	Max.	Units
Resolution	12bit		0.04		%RH
	8 bit		0.7		%RH
Accuracy/ Tolerance	Typical		±3.0		%RH
	Max.		See figure		%RH
Repeatability			±0.1		%RH
Hysteresis			±1		%RH
Non-linearity			<0.1		%RH
Response time	τ63%		8		s
Operative range	Extended	0		100	%RH
Long-term drift	Normal		<0.5		%RH/year

Humidity measurement tolerance

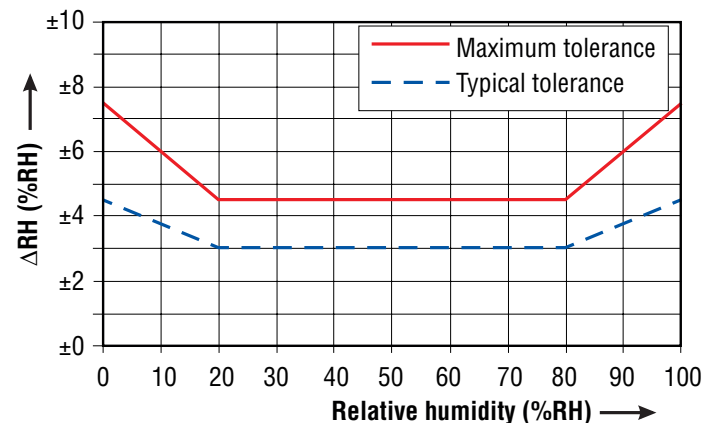

6.1.2 Temperature

Parameter	Condition	Min.	Typical	Max.	Units
Resolution	14 bit		0.04		°C
	8 bit		0.7		°C
Accuracy/Tolerance	Typical		±3.0		°C
	Max.	See figure			°C
Repeatability			±0.1		°C
Operative range	Extended	-40		125	°C
Response time	τ63%	5		30	s
Long-term drift	Normal		<0.04		°C/year

Accuracy of temperature measurement

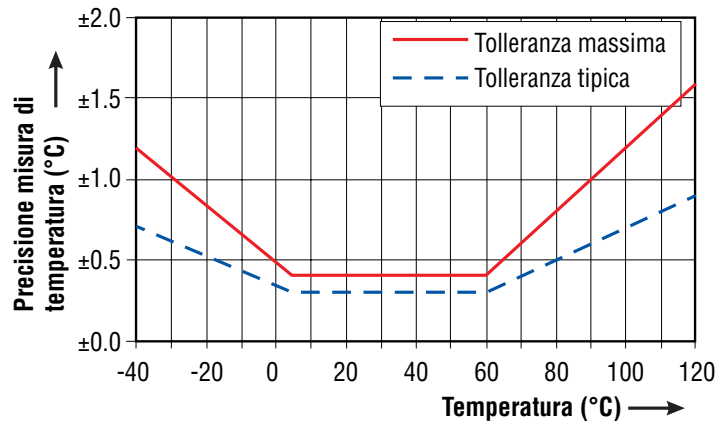

6.2 Filter characteristics

6.2.1 Technical specifications

Parameter	Value
Protection degree (1)	IP67
RoHS	Compliant
Body material	Polybutylene terephthalate (PBT)
Body colour	Black
UL94 (body material only)	UL-94 V-0 (0.73 mm)
Filter material	PTFE with polyester scrim
Filter colour	Black
Filter thickness	0.13 mm
Filter pore size	1.5 µm
Filtration efficiency (2)	99.99%
Oleophobic Range (filter)(3)	8
Mullen Hydrostatic	>100 mbar (>1 m water)

- Notes:**
1. IP67: dust tight, protected against harmful water immersion up to 1 m water column (<http://en.wikipedia.org/wiki/IP67>);
 2. 0.1 µm particles at 0.05 m/s air flow;
 3. Repellence of oil and hydrocarbons according to AATC 118.1992 standard. Rating goes from 0 ÷ 8 while 8 is the most repellent.

6.3 Functional features

- Protection degree:** IP67 ((protected against dust and against the effects of temporary immersions);
- Installation method:** With clip;
- Electrical connections:** With 5 m wire;
- Dimensions (mm):** L = 130 mm + spirale, Ø16 mm;
- Operating temperature:** -30 ÷ +80°C;
- Ambient humidity:** 0 ÷ 100% RH;
- Sensor type:** CMOS;
- Humidity measuring range:** 0 ÷ 100% RH;
- Total accuracy:** Sensor accuracy +0.2%;
- Output current (RH measurement):** 4 (0%) ÷ 20mA (100%);
- Output impedance R out:** 100Ω;
- RH calibration:** 0% @ 0V,
100% @ 10V;
- Temperature calibration:** -30°C @ 0V,
100°C @ 10V;
- Response time at constant conditions (63%) at 23°C:** 10 s;
- Recovery time from saturation:** 15 s
- Storage temperature:** -30 ÷ +80°C.

