

# Double action controller with analogue output 1/8 DIN - 48 x 96 mm gammadue® series X3 line

## Analogue control within everyone's reach

Including Auto/Man selection  
and digital inputs for external  
activation of:

- Stored Setpoints
  - Timer function
  - Setpoint programmable profile
- the gammadue® X3 line  
is simple, yet is suitable to satisfy  
almost all control needs:
- time proportioning
  - analogue
  - single or double action
  - valve drive

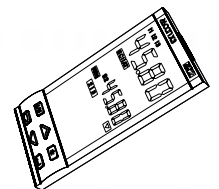
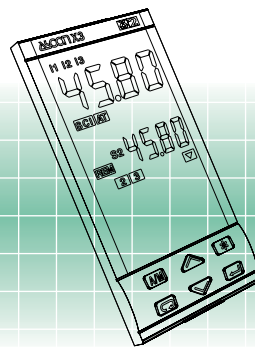
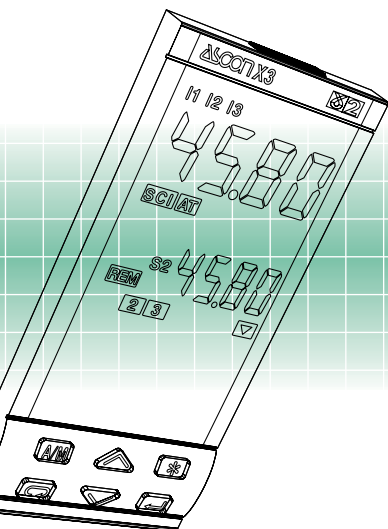

E

ISO 9001 Certified

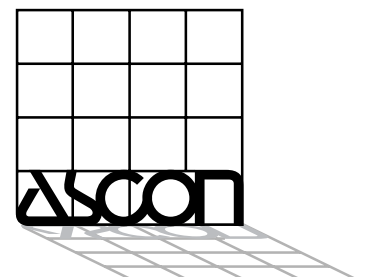



# gammadue<sup>®</sup>

the right solution to your needs

Your needs	Our solutions
Heaters failure	Heater break alarm with current transformer
Use of different actuators	Analogue output, heat/cool (linear, water, oil), valve control output
Easy replacement and quick start-up	Configuration by simple to use codes
Correct tuning for any condition	Automatic selection between two different tuning methods
Alarm signalling	Absolute, band and deviation alarms, Latching/Blocking
Interfacing with other devices	Serial communications at 9600 baud Modbus/Jbus protocol, analogue retransmission output, Remote Setpoint and 3 digital inputs
Frequent Setpoint change	Two stored Setpoints selected by keypad, serial communications or digital inputs
Quick learning	Every model has the same operating method
Ergonomic compatibility with other devices	Two colours: beige or darkgrey front panels
Environmental protection	IP65 front panel protection (indoor, dust and water protection)
Easy to use	Ergonomic keypad, clear and comprehensive display
Noise immunity	Electromagnetic compatibility
Universal input signals, linear as well as non-linear	Configurable input (TC, RTD, mA, Volt and ΔT, infrared sensor, "custom" linearisation)
Costs reduction	Built-in Timer and Start-up functions
Reliability and safety	CE compatibility, ASCON is ISO 9001 certified, 3 years warranty
Technical support	Technical application assistance from ASCON sales and after sales service

## Resources

## Operating mode

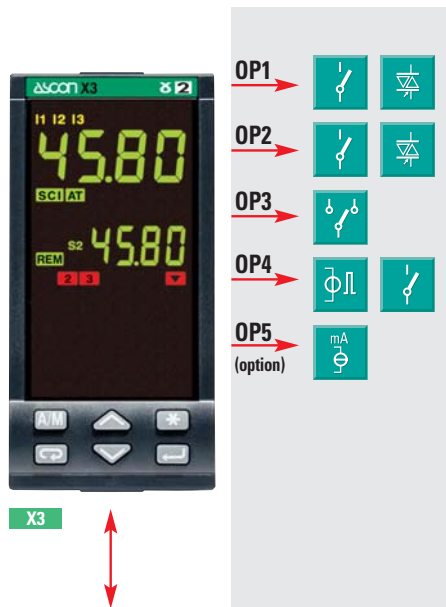
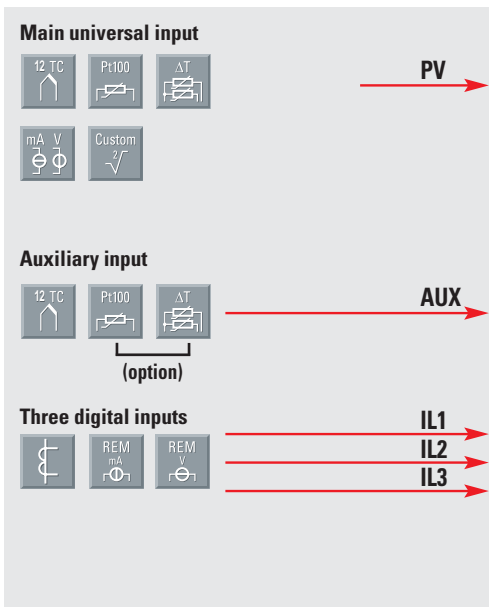

	Control	Alarms	Retransmission
	PV/SP		
1	OP1	OP2 OP3	OP5
2	OP4	OP1 OP2 OP3	OP5
3	OP5	OP1 OP2 OP3	
4	OP1 OP2	OP3	OP5
5	OP1 OP4	OP2 OP3	OP5
6	OP4 OP2	OP1 OP3	OP5
7	OP1 OP5	OP2 OP3	
8	OP5 OP2	OP1 OP3	
9	OP5 OP4	OP1 OP2 OP3	
10	OP1 OP2	OP3	OP5

**Setpoint**

LOC   2 MEM   REM   1x8s

**Modbus RS485**  
Parameterisation  
Supervision  
(option)

**Fuzzy tuning with automatic selection**

One shot Auto tuning   One shot Natural Frequency

**IL1, IL2 or IL3 connected functions**

MEM   REM   RUN   HOLD PV   TIMER   START UP   TIMER

**Special functions (option)**

TIMER   START UP   TIMER

## Technical data

Features at env. 25°C	Description				
Total configurability	From keypad or serial communications, the user selects: type of input - associated functions and corresponding outputs - type of control algorithm - type of output and safe conditions - alarm types and functionality - control parameter values				
PV input for signal ranges see table 1)	Common characteristics	A/D converter with 50,000 points Update measurement time: 0.2 s Sampling time: 0.5 s Input shift: - 60...+ 60 digit Input filter: 1...30 s (OFF= 0)			
	Accuracy	0.25% ± 1 digit (T/C and RTD) 0.1% ± 1 digit (mA and mV)	Between 100 and 240Vac error is minimal		
	Resistance thermometer (for ΔT: R1+R2 must be <320Ω)	Pt100Ω at 0°C (IEC 751) °C/°F selectable	2 or 3 wire connection Burnout (with any combination)	Line: 20 Ω max (3 wire) Thermal drift 0.35°C/10°C env. T. 0.35°C/10 Ω line resist.	
	Thermocouple	L, J, T, K, S, R, B, N, E, W3, W5 (IEC 584) °C/°F selectable	Internal cold junction compensation with NTC Error 1°C/20°C ± 0.5°C Burnout	Line: 150 Ω max Thermal drift <2μV/°C env. T. <5μV/10 Ω line resist.	
	DC input (current)	0/4...20mA, 2.5 Ω ext. shunt Rj >10MΩ	Burnout. Engineering units, floating decimal point, configurable Low Range -999...9999 High Range -999...9999 100 digits minimum	Input drift: <0.1% / 20°C env. T. <5μV/10 Ω line resist.	
	DC input (voltage)	0/10...50mV, Rj >10MΩ			
	Auxiliary inputs	Remote Setpoint (option) Not isolated accuracy 0.1%	Current 0/4...20mA Rj = 30Ω Voltage 1...5/0...5/0...10V Rj = 300kΩ	Bias in engineering units and ± range Ratio from -9.99...+99.99 Local + Remote	
CT current transformer		50 or 100mA input hardware selectable	Current visualization 10...200 A with 1A resolution and Heater break alarm		
Digital inputs 3 logic		The closure of the external contact produces any of the following actions	Auto/Man mode change, Local/Remote Setpoint mode change, Stored Setpoints activation, keypad lock, measure hold Timer activation, program run/hold (if options installed)		
Operating modes	1 single or double action P.I.D. loop or ON/OFF with 1, 2 or 3 alarms				
Control mode	Algorithm	P.I.D. with overshoot control or ON/OFF PID with valve algorithm, for controlling motorised positioners			
	Proport. band (P)	0.5...999.9%	User Enabled/Disabled		
	Integral time (I)	0.1...100.0 min			
	Derivative time (D)	0.01...10.00 min			
	Error dead band	0.1...10.0 digit			
	Overshoot control	0.01...1.00	Single action PID algorithm		
	Manual reset	0.0...100.0%			
	Cycle time (Time proportional only)	1...200 s			
	Control output high limit	10.0...100.0%			
	Soft-start output value	0.1...100.0%	User Enabled/Disabled	ON/OFF algorithm	
	Output safety value	0.0...100.0% (-100.0...100.0% for Heat/Cool)			
	Control output hysteresis	0.1...10.0%			
	Dead band	-10.0...10.0%			
	Relative cool gain	0.1...10.0	Double action PID algorithm (Heat/Cool) with overlap		
Cycle time (Time proportional only)	1...200 s				
Cool output high limit	10.0...100.0%				
Cool output hysteresis	0.1...10.0%				
Motor travel time	15...600 s	Valve PID algorithm without feedback potentiometer			
Motor minim. step	by 0.1...5.0%				

Input type	Scale range
RTD Pt100 IEC751	-99.9...300.0 °C
	-99.9...572.0 °F
RTD Pt100 IEC751	-200...600 °C
	-328...1112 °F
TC L Fe-Const DIN43710	0...600 °C 32...1112 °F
TC J Fe-CU45% NI IEC584	0...600 °C
	32...1112 °F
TC T Cu-CuNi	-200...400 °C
	-328...752 °F
TC K Cromel-Alumel IEC584	0...1200 °C 32...2192 °F
TC S Pt10%	0...1600 °C
Rh-Pt IEC584	32...2912 °F
TC R Pt13% Rh Pt IEC584	0...1600 °C 32...2912 °F
TC B Pt30% Rh Pt 6% IEC584	0...1800 °C 32...3272 °F
TC N Nichrosil-Nisil IEC584	0...1200 °C 32...2192 °F
TC E Ni10% CR CuNi IEC584	0...600 °C 32...1112 °F
TC NI-NiMo18%	0...1100 °C 32...2012 °F
TC W3%Re W25%Re	0...2000 °C 32...3632 °F
TC W5%Re W26%Re	0...2000 °C 32...3632 °F
0/4...20 mA 0/10...50 mV mV Custom scale	Configurable engineering units mA, mV, V, bar, psi, Rh, ph On request

Table 1: PV input

## Special functions

To improve the instrument performance and to reduce the wiring and installation costs, two special functions are available:

### - Start-up

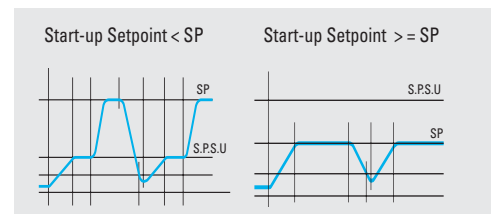

### - Timer

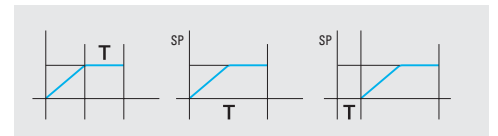

The use of these functions avoids additional device installation (e.g. external timer), therefore allowing a significant costs reduction.

Moreover there are:

- **Keypad lock/unlock** function, to avoid incorrect operator actions
- **Outputs lock/unlock** function, at any moment it is possible to stop the control action, but not the process variable display, without switching-off the power supply.

## Technical data

Features at env. 25°C	Description		
OP1-OP2 outputs	SPST relay N.O., 2A/250Vac (4A/120Vac) for resistive load Triac, 1A/250Vac for resistive load		
OP3 output	SPDT relay N.O., 2A/250Vac (4A/120Vac) for resistive load		
OP4 output	SSR drive not isolated: 0/5Vdc, ± 10%, 30mA max. SPST relay N.O., 2A/250Vac (4A/120Vac) for resistive load		
OP5 (option) analogue control output	Control or PV/SP retransmission	Galvanically isolated: 500Vac /1min Resolution: 12 bit Accuracy: 0,1%	In current: 0/4...20mA, 750Ω /15V max.
AL1- AL2 - AL3 alarms	Hysteresis		0.1...10.0%
	Action	Active high	Action type
		Active low	Deviation threshold ± range Band threshold 0...range Absolute threshold, whole range
		Special functions	Sensor break, Heater break and Loop break detection Acknowledge (latching), activation inhibit (blocking) Connected to Timer or program (if options installed)
Setpoint	Local	Up and down ramps 0.1...999.9 digit/min (OFF=0)	
	Local plus two stored (tracking or Stand-by)		
	Local and Remote	If option installed	Low limit: from low range to high limit
	Local with trim		High limit: from low limit to high range
	Remote with trim		
Programmable	1 program, 8 segments 1 initial and 1 end, from 1 to 9999 cycles or continuous cycling (OFF)		
Programmable Setpoint (option)	Start, stop, hold, etc. activated from the keypad, digital input and serial comm.s		
Special functions (options)	Timer	Automatic start at the power on, manual start by keypad, digital inputs or serial communications	
		Setting time: 1...9999 s/min Stand-by Setpoint: from Setpoint low limit to Setpoint high limit	
Start-up	Start-up Setpoint: from Setpoint low limit to Setpoint high limit		Control output high limit: 5.0...100.0%
	Hold time: 0...500 min		
	Step response		
One-shot Fuzzy-Tuning	Depending on the process condition, the controller applies the best method	Natural frequency	
Auto/Man selection	Standard with bumpless function, by keypad, digital input or serial communications		
Serial comm.s (option)	RS 485 isolated, Modbus/Jbus protocol 1200, 2400, 4800, 9600 bit/s, three wires		
Auxiliary power supply	+24Vdc ±20%, 30 mA max. for external transmitter supply		
Operational safety	Measure input	Detection of out of range, short circuit or sensor break with automatic activation of the safety strategies and alerts on display	
	Control output	Safety value: -100%...100%	
	Parameters	A non volatile memory stores for unlimited time all the configuration and parameter values	
	Password	Password to access the configuration and parameters data, keypad lock, outputs lock	
General characteristics	Power supply (fuse protected)	100...240Vac (-15...+10%) 50/60Hz or 240Vac (-15...+25%) 50/60Hz and 24Vdc (-25...+12%)	Power consumption 4W max.
	Safety	Compliance EN61010-1 (IEC 1010-1), installation class 2 (2,5kV), pollution class 2, class II instrument	
	Electromagnetic compatibility	Compliance to the CE standards for industrial system and equipment	
	Approval UL and cUL	File E176452	
	Protection EN60529 (IEC529)	IP65 front panel	
Dimensions	1/8 DIN - 48 x 96, depth 110 mm, weight 250g appr.		

## Electrical wirings

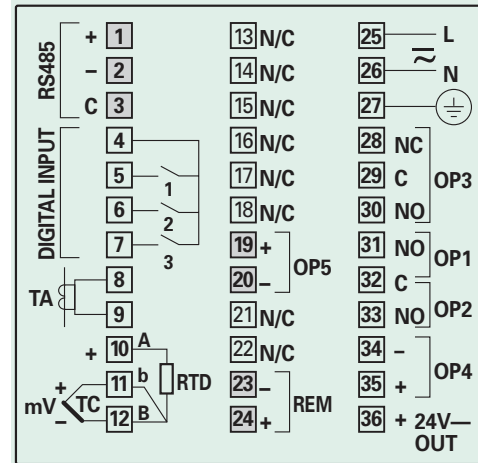

## Fuzzy-Tuning

Two methods of tuning are available:

- **Auto-Tuning "one shot"**
- **Natural frequency "one shot"**

The **Fuzzy-Tuning** automatically selects one of the two methods which assures the best result for each condition.

The **Auto-Tuning** method works best on the step response basis.

When activated, if a deviation exists between the Setpoint and process variable larger than 5% of scale range, the controller modifies the output value. Then, in a short time, it calculates the PID parameters and the new algorithm is operational immediately.

The main advantages of this method are fast calculation and quick implementation.

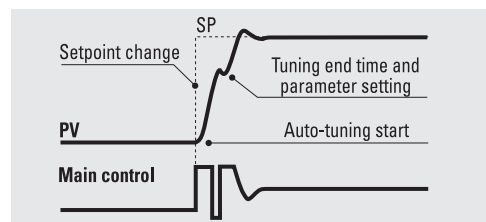

The **Natural frequency** method works best when the process variable is very near to the Setpoint. When activated, it causes a process oscillation around the Setpoint value.

The main advantage of this method is a reduced disturbance to the process.

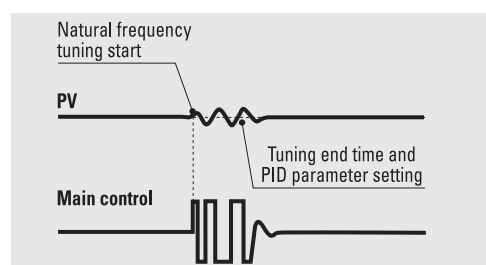

## Ordering codes

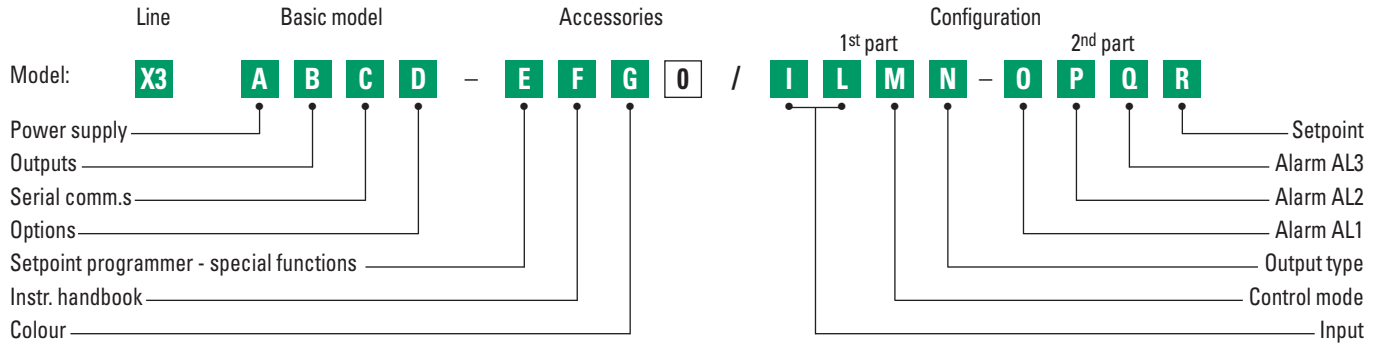

<b>Power supply</b>	<b>A</b>
100...240Vac (-15...+10%)	3
24V (-25...+12%) or 24Vdc (-15...+25%)	5
<b>OP1-OP2-OP4 outputs</b>	<b>B</b>
Relay-Relay-SSR Drive	1
Triac-Triac-SSR Drive	5
Relay-Relay-Relay	9
<b>Serial communications</b>	<b>C</b>
Not fitted	0
RS 485 Modbus/Jbus SLAVE	5
<b>Options</b>	<b>D</b>
None	0
Valve drive output (no potentiometer)	2
Analogue output + Remote Setpoint	5
Valve drive output + Analogue output (retr.) + Remote Setpoint	7
<b>Setpoint programmer - special functions</b>	<b>E</b>
Not fitted	0
Start-up + Timer	2
One "8 segments" program	3
<b>Instruction handbook</b>	<b>F</b>
Italian-English (std)	0
French-English	1
German-English	2
Spanish-English	3
<b>Front case colour</b>	<b>G</b>
Dark (std)	0
Beige	1

<b>Input type</b>	<b>Range scale</b>	<b>I</b>	<b>L</b>
RTD Pt100 IEC751	-99.9...300.0 °C -99.9...572.0 °F	0	0
RTD Pt100 IEC751	-200...600 °C -328...1,112 °F	0	1
TC L Fe-Const DIN43710	0...600 °C 32...1,112 °F	0	2
TC J Fe-Cu45% Ni IEC584	0...600 °C 32...1,112 °F	0	3
TC T Cu-CuNi	-200...400 °C -328...752 °F	0	4
TC K Chromel -Alumel IEC584	0...1,200 °C 32...2,192 °F	0	5
TC S Pt10%Rh-Pt IEC584	0...1,600 °C 32...2,912 °F	0	6
TC R Pt13%Rh-Pt IEC584	0...1,600 °C 32...2,912 °F	0	7
TC B Pt30%Rh-Pt	0...1,800 °C 32...3,272 °F	0	8
Pt6%Rh IEC584			
TC N Nicrosil-Nisil IEC584	0...1,200 °C 32...2,192 °F	0	9
TC E Ni10%CR-CuNi IEC584	0...600 °C 32...1,112 °F	1	0
TC Ni NiMo 18%	0...1,100 °C 32...2,012 °F	1	1
TC W3%Re-W25%Re	0...2,000 °C 32...3,632 °F	1	2
TC W5%Re-W26%Re	0...2,000 °C 32...3,632 °F	1	3
0...50mV linear	Engineering units	1	4
10...50mV linear	Engineering units	1	5
mV "Custom" scale	On request	1	6
<b>Control mode</b>		<b>M</b>	
ON-OFF reverse action		0	
ON-OFF direct action		1	
PID single reverse action		2	
PID single direct action		3	
	Linear cool output	4	
	ON-OFF cool output	5	
	Water cool output	6	
	Oil cool output	7	
<b>Output type - Single action</b>	<b>Output type - Double action</b>	<b>N</b>	
Relay (OP1)	Heat (OP1), Cool (OP2)	0	
Digital (OP4)	Heat (OP1), Cool (OP4)	1	
Analogue (OP5)	Heat (OP4), Cool (OP2)	2	
Valve drive (OP1 and OP2)	Heat (OP1), Cool (OP5)	3	
	Heat (OP5), Cool (OP2)	4	
	Heat (OP4), Cool (OP5)	5	
	Heat (OP5), Cool (OP4)	6	
<b>AL1-AL2-AL3 type and function</b>		<b>O-P-Q</b>	
Disabled or (only AL3) used by Timer or related to the program		0	
Sensor break/Loop break alarm		1	
Absolute	active high	2	
	active low	3	
Deviation	active high	4	
	active low	5	
Band	active out	6	
	active in	7	
Heater break by CT	active during ON output state	8	
	active during OFF output state	9	
<b>Setpoint type</b>		<b>R</b>	
Local only		0	
Local and 2 tracking stored Setpoints		1	
Local and 2 Stand-by stored Setpoints		2	
Local and Remote (if option installed)		3	
Local with trim (only with remote Setpoint)		4	
Remote with trim (if option installed)		5	
Time programmable (if option installed)		6	

**If not differently specified the controller will be supplied with standard version  
Model: X3 3100-0000**





S E R I E S

## ASCON spa

Via Falzarego, 9/11  
20021 Baranzate  
(Milano) Italy  
Tel. +39 02 333 371  
Fax +39 02 350 4243  
<http://www.ascon.it>  
[sales@ascon.it](mailto:sales@ascon.it)

## ASCON FRANCE

2 bis, Rue Paul Henri Spaak  
ST. THIBAUT DES VIGNES  
F-77462 LAGNY SUR  
MARNE - Cedex  
Tél. +33 (0) 1 64 30 62 62  
Fax +33 (0) 1 64 30 84 98  
[ascon.france@wanadoo.fr](mailto:ascon.france@wanadoo.fr)

### AGENCE EST

Tél. +33 (3) 89 76 99 89  
Fax +33 (3) 89 76 87 03

### AGENCE SUD-EST

Tél. +33 (0) 4 74 27 82 81  
Fax +33 (0) 4 74 27 81 71

## ASCON CORPORATION

472 Ridgelawn Trail  
Batavia, Illinois 60510  
Tél. +1 630 482 2950  
Fax +1 630 482 2956  
[www.asconcorp.com](http://www.asconcorp.com)  
[info@asconcorp.com](mailto:info@asconcorp.com)

### WORLDWIDE NETWORK OF DIRECT SALES CENTERS, DISTRIBUTORS AND VARs

#### Europe

Belgium, Croatia, Czech Rep.,  
Denmark, Estonia, Finland, France,  
Germany, Great Britain, Greece,  
Holland, Ireland, Norway, Poland,  
Portugal, Romania, Russia, Slovakia,  
Slovenia, Spain, Sweden, Switzerland,  
Turkey, Ukraine

#### Americas

Argentina, Brazil, Canada, Chile,  
Colombia, Ecuador, Mexico, Paraguay,  
Peru, Uruguay, Venezuela

#### Rest of the world

Algeria, Australia, China, Egypt,  
Hong Kong, India, Indonesia, Iran,  
Israel, Malaysia, Morocco, New  
Zeland, Pakistan, Saudi Arabia,  
Singapore, Taiwan, Thailand, Tunisia,  
South Africa & South East Africa,  
UAE

