



T31

DIGITAL ELECTRONIC MICROPROCESSOR TIMER



User Manual

Cod.: 21/11 - ISTR_M_T31_E_02_--

ASCON TECNOLOGIC S.r.l.

Viale Indipendenza 56, 27029 - VIGEVANO (PV) ITALY

TEL.: +39 0381 69871 - FAX: +39 0381 698730

sito: <http://www.ascontecnologic.com>

e-mail: info@ascontecnologic.com

Index

1. Instrument description	1
1.1 General description.....	1
1.2 Front panel description	2
2. Programming	2
2.1 Fast Set Times programming.....	2
2.2 Standard mode parameters setting.....	2
2.3 Parameter protection using a password.....	3
2.4 Customized mode parameter programming (parameters programming level).....	3
2.5 Reset parameters to default value	3
2.6 Keyboard lock function.....	3
3. Usage warnings	3
3.1 Allowed Usage	3
4. Installation warnings	4
4.1 Mechanical Mounting.....	4
4.2 Mechanical Dimensions [mm].....	4
4.2.1 Instrument dimensions	4
4.2.2 Panel cutout.....	4
4.2.3 Mounting brackets	4
4.3 Electrical connections	4
4.3.1 Electrical connection diagram.....	4
5. Operating mode	5
5.1 Display operation	5
5.2 Operation of the Counting commands	5
5.3 Out1 Operating mode	6
5.4 Out2 Operating mode	6
5.5 Internal buzzer operation	9
5.6 Operation in case of power supply failure (backup)	9
6. Accessories	9
6.1 Parameters configuration with A01	9
6.2 Parameters configuration with AFC1	10
7. Programmable parameters table	11
8. Problems and maintenance	12
8.1 Cleaning.....	12
8.2 Disposal	12
9. Warranty and repairs	12
10. Technical data	12
10.1 Electrical data	12
10.2 Mechanical characteristics.....	12
10.3 Functional features	12
11. How to order	13

PREFACE

 This manual contains the information necessary for the product to be installed correctly and also instructions for its maintenance and use; we therefore recommend that the utmost attention is paid to the following instructions and to save it.

This document is the exclusive property of Ascon Technologic S.r.l. which forbids any reproduction and divulgation, even partially, of the document, unless expressly authorized.

Ascon Technologic S.r.l. reserves the right to make any formal or functional changes at any moment and without any notice.

Ascon Technologic S.r.l. and its legal representatives do not assume any responsibility for any damage to people, things or animals deriving from violation, wrong or improper use or in any case not in compliance with the instrument features.

 Whenever a failure or a malfunction of the device may cause dangerous situations for persons, thing or animals, please remember that the plant has to be equipped with additional devices which will guarantee safety.

1. INSTRUMENT DESCRIPTION

1.1 General description

T31 is a digital microprocessor timer, it offers the possibility to program: **up to 3 delay times** (or Set Times), **6 operating modes** for **Out1** output, **10 operating modes** for **Out2** output, **4 time scales** (allowing timings from 9999 hours max. to 0.01 s min.), **6 counting start modes** and **2 counting modes** (**UP** or **DOWN**). The timer can also be equipped with an **internal or external buzzer** for signaling the end of the count.

The **4 digits display** normally shows the **counting status** while the outputs status is signalled by **2 LEDs**. The instrument has also **2 digital inputs** for voltage-free contacts that can be used for the **count enabling (CNT EN)** and **Reset (RES)** commands and can have **up to 2 relay outputs** or **SSR for driving Solid State Relays**.

The instrument is programmed by using the 3 of the front panel keys while the counting commands can be submitted using the **U-Start/Stop** or through the digital inputs **CNT EN** and **RES**. The operating parameters configuration can be done through **keypad**, **A01** device connected to **TTL port** (standard) or using **NFC** communication (optional).

1.2 Front panel description

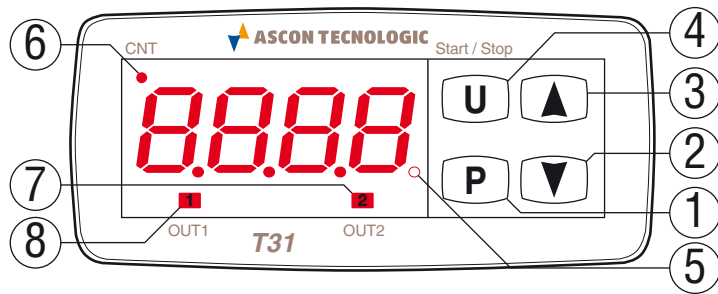

1. **P**: Pressed and released allows to set the time delays (if programmed with tEd parameter). Pressed for 5 s enters the parameters program mode, pressed again accesses the parameters edit mode and confirms values. In programming mode can be used together with the **▲** key to change the programming level of the parameters. When the keyboard is locked, **P** and **▲** keys hold pressed together for 5 s, unlock the keyboard.
2. **▼**: In parameters program mode is used to decrease the setting values and to select the parameters.
3. **▲**: In parameters program mode is used to increase the setting values and to select the parameters. In programming mode can be used together with **P** key to change parameters level. Pressed together with the **P** key for 5 s allows the keyboard unlock.
4. **U-Start/Stop**: Can be used for Start/Stop/Reset count commands as programmed using the tUF parameter;
5. **LED SET**: In normal operating mode, indicates the entering to timings setting mode. In programming mode is used to indicate the parameter programming level.
6. **LED CNT**: Indicates: count in progress (flashing with a 1 s frequency), count interrupted (on steady) or the reset status (off);
7. **LED Out1**: Indicates the Out1 output status: ON (lit), OFF (not lit);
8. **LED Out2**: Indicates the Out2 output status: ON (lit), OFF (not lit).

2. PROGRAMMING

2.1 Fast Set Times programming

The normal mode to program the delay times (Set Times) is done by shortly pressing **P** key, the **SET** LED lights up and display starts showing alternatively S_{t1} (parameter acronym) and its programmed value. To change the value press the **▲** key to increase the number shown or **▼** to decrease it. These 2 keys normally act in one digit steps a time, but if kept pressed for more than 1 s the value increases or decreases faster and after 2 more seconds in the same condition, the speed further increases in order to quickly reach the desired value. However, through $tEdt$ parameter it is possible to define if and which Set Time can be set with the **P** short key. A further option provides the setting of S_{t1} Set Time value only, using the **▲/▼** keys without pressing in advance the **P** key ($tEd = 8$). tEd parameter can assume a value between **0F** and **8**:

0F No Set Time can be set with the **P** short key (if pressed and released, the **P** key has no effect);

1. Only S_{t1} Set Time value can be set with this procedure;
2. Only S_{t2} Set Time value can be set with this procedure;
3. S_{t1} and S_{t2} Set Times can be set with this procedure;

4. Only S_{t3} Set Time value can be set with this procedure;
5. S_{t1} and S_{t3} Set Times can be set with this procedure;
6. S_{t2} and S_{t3} Set Times can be set with this procedure;
7. S_{t1} , S_{t2} and S_{t3} Set Times can be set with this procedure;
8. S_{t1} Set Time value can be set directly using **▲/▼**.

For example, in case the parameter $tEdt = 1$ or **3**, the procedure is the following:

- Press and release the **P** key, the display shows S_{t1} alternated to the S_{t1} value.
- To change the Set Time, press the **▲** key to increase the value or **▼** to decrease it.
- If $tEd = 1$, once the desired value has been set, press the **P** button to exit the fast programming mode.
- If $tEd = 3$, pressing and releasing again the **P** button the display shows S_{t2} alternated to its value. To change the value use the **▲/▼** keys as for the S_{t1} value.
- Once the Set Time time has been programmed, press the **P** key to exit the Set Time programming mode.

To exit the fast Set Time programming mode push the **P** key after the last Set Time time has been displayed or pressing no buttons for about 10 s, after which the display returns to normal operation.

S_{t1} and S_{t3} can be set within the limits established by parameters $S_{L_{t1}}$ and $S_{H_{t1}}$ while S_{t2} within the limits established by $S_{L_{t2}}$ and $S_{H_{t2}}$.

2.2 Standard mode parameters setting

To access the instrument function parameters when password protection is disabled, press the **P** key for 5 s, after which the display shows the code that identifies the first programmable parameter; use the **▲/▼** keys to select the desired parameter then press the **P** key, the display shows the parameter code alternated to its value that can be changed with the **▲** and **▼** keys. Once the desired value has been set, press the key **P** again: the new value is stored and the display shows only the code of the modified parameter. Pressing the **▲** or **▼** keys, it is possible to select another parameter and change it as described. To exit the programming mode, press no keys for 30 s or keep the **U** key pressed for 2 s, the timer returns showing the actual count value.

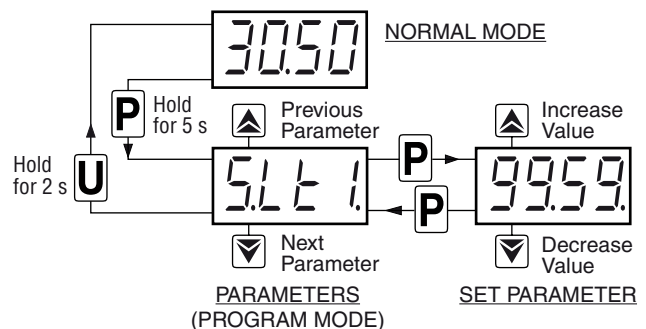

2.3 Parameter protection using a password

The instrument has a parameter protection function using a password that can be personalised through the $\epsilon.PP$ parameter. To protect the parameters, set the desired password number at parameter $\epsilon.PP$.

When the protection is active, press the P key for 5 s after which the display shows $r.P$. Press the P key, display shows \square . Using \uparrow/\downarrow keys, insert the programmed password number and press the P key again.

If Password is correct the instrument displays the code of the first parameter. Now is possible to program the instrument in the same way previously described.

Password protection can be disabled by setting $\epsilon.PP = \text{oF}$.

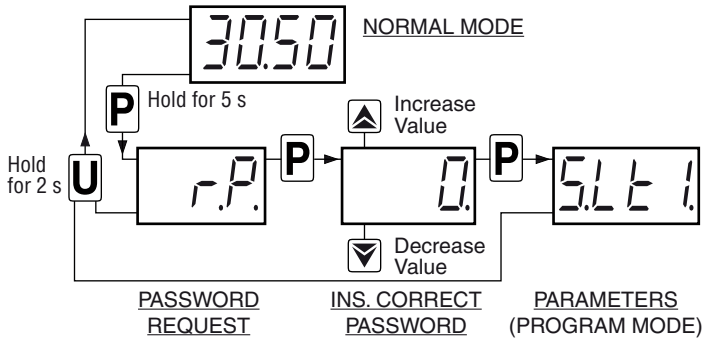

- Notes:**
- All parameters are configured by default as “**protected**” so that by simply setting the $\epsilon.PP$ parameter they are all protected by the Password.
 - If the Password gets lost, just **switch OFF** then **ON the instrument**, push P key during the initial test keeping it pressed for 5 s. In this way it is possible to access all the parameters, verify and modify the parameter $\epsilon.PP$.

2.4 Customized mode parameter programming (parameters programming level)

When activated, the password protection acts on all parameters. If, once enabled the Password through the $\epsilon.PP$ parameter, it is necessary to make certain parameters programmable without protection while keeping the protection on the others, follow the procedure below:

- Enter the program mode using the $\epsilon.PP$ Password and, with \uparrow/\downarrow keys, select the parameter that must be accessible (no password protection).
- Once the parameter is selected, if the **SET LED flashes**, the parameter is programmable only entering the password (“*protected*”). If **SET LED is steady ON** the parameter is programmable without password (“*unprotected*”).
- To change the parameter visibility, press the P key and keeping it pressed press also the \uparrow button.
- The **SET LED changes its state** indicating the new level of parameter accessibility (**ON** = *Not protected*; **Flashing** = *Password protected*).

In case some parameters are set as **Not protected**, accessing the programming mode the display **first** shows the **Not protected** parameters, then the $r.P$ parameter through which will be possible to access also the **protected** parameters.

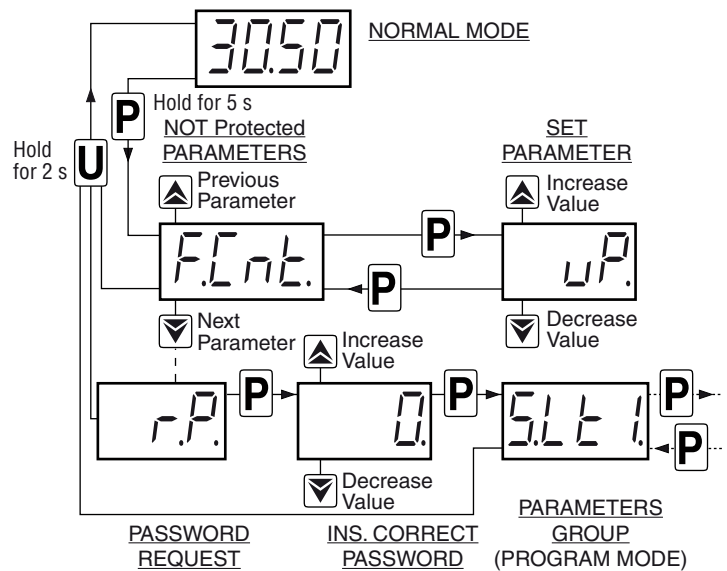

2.5 Reset parameters to default value

The instrument allows to reset all parameters to the values programmed in factory as default. To restore the default parameters value set value $-4B$ at $r.P$ password request. Therefore, to make the reset to the default parameters, enable the Password using the $\epsilon.PP$ parameter so that the $r.P$ setting is requested, at this point insert $-4B$ instead of the programmed access password. Once confirmed the password with the P key the display shows “- - -” for 2 s, then the instrument resets all the parameters to factory default setting.

2.6 Keyboard lock function

It is possible to completely lock the keyboard. This function is useful when the controller is used in an accessible area and unauthorized changes must be avoided. To activate the keyboard lock, program the parameter $\epsilon.L\sigma$ to a value different from oF . The $\epsilon.L\sigma$ value is the keys inactivity time after which the keyboard is automatically locked. When the keyboard is locked, if any of the key is pressed, the display shows $L\sigma$ to indicate that the lock is active. To unlock the keyboard, press contemporarily $\text{P} + \uparrow$ keys and keep them pressed for 5 s, after which the label $L\sigma$ appears on the display and all the key functions will be available again.

3. USAGE WARNINGS

3.1 Allowed Usage



The instrument has been projected as measure and control device, built according to EN61812-1 for the altitudes operation below 2000 ms.

Using the instrument for applications not expressly permitted by the above mentioned rule must adopt all the necessary protective measures.

The instrument **must not be used in dangerous environments** (flammable or explosive) without adequate protections.



The installer must ensure that the EMC rules are respected, also after the instrument installation, if necessary using proper filters.

4. INSTALLATION WARNINGS

4.1 Mechanical Mounting

The instrument, in 78 x 35 mm case, is designed for flush-in panel mounting. Make a 71 x 29 mm hole and insert the instrument, fixing it with the provided special brackets. To obtain the declared protection degree (IP65), the optional screw type bracket must be used.

Avoid placing the instrument in dirty environments or with very high humidity levels that may create condensation and avoid the introduction of conductive substances into the instrument. Ensure adequate ventilation to the instrument and avoid installation in containers that house devices which may overheat or which may cause the instrument to function at a temperature higher than the one permitted and declared. Connect the instrument as far away as possible from sources of electromagnetic disturbances such as motors, power relays, relays, solenoid valves, etc..

4.2 Mechanical Dimensions [mm]

4.2.1 Instrument dimensions

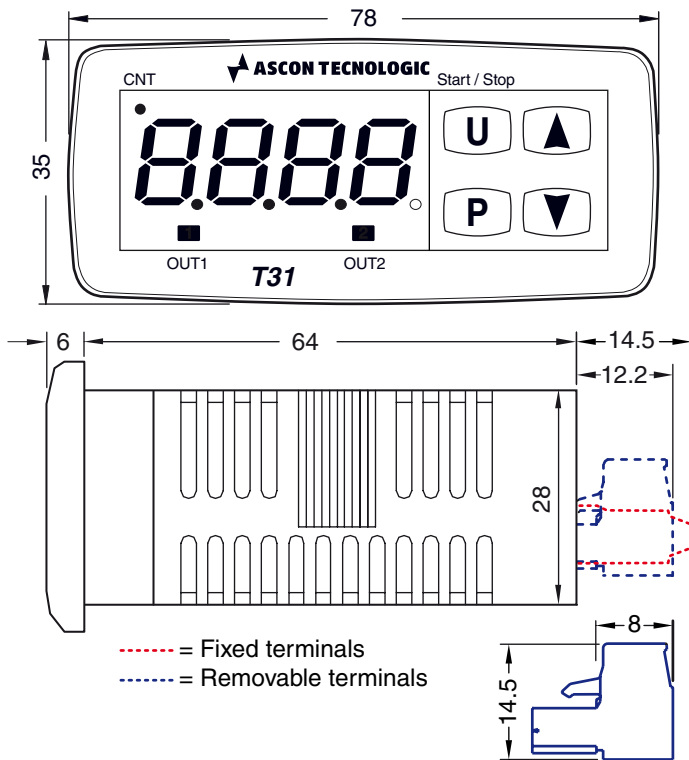

4.2.2 Panel cutout

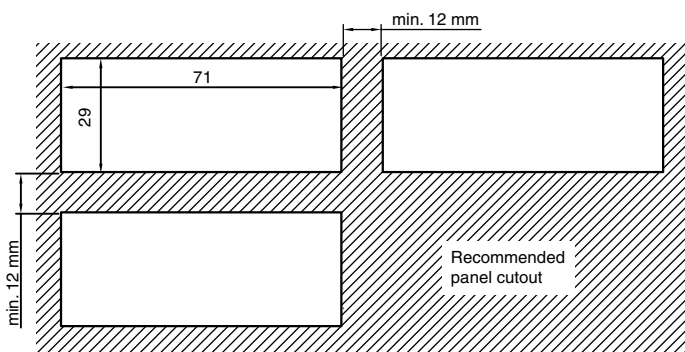

4.2.3 Mounting brackets

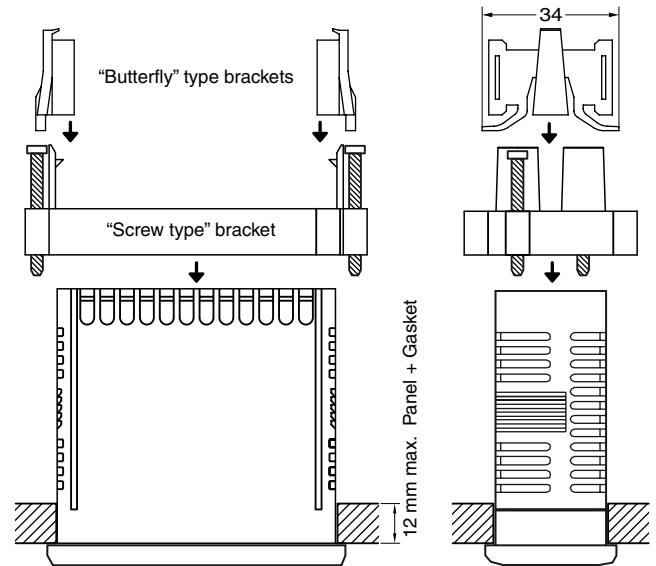

4.3 Electrical connections

Carry out the electrical wiring by connecting only one wire to each terminal, according to the following diagram, checking that power supply is the same as indicated on the instrument and the load current absorption is no higher than the maximum electricity current permitted.

As the instrument is built-in equipment with permanent connection inside housing, it is not equipped with either switches or internal devices to protect against current overloads: the installation will include an overload protection and a two-phase circuit-breaker, placed as near as possible to the instrument and located in a position that can easily be reached by the user and marked as **instrument disconnecting device** which interrupts the power supply to the equipment. It is also recommended that the supply of all the electrical circuits connected to the instrument must be properly protected, using devices (ex. fuses) proportionate to the circulating currents. It is strongly recommended that cables with proper insulation, according to the working voltages and temperatures, be used. If some cables are shielded, the shield must be connected to ground at only one side.



Moreover, check that the parameters set are the desired ones and the application works correctly **before connecting the outputs to the actuators** in order to avoid malfunctions in the plant that could cause damage to people, things or animals.

4.3.1 Electrical connection diagram

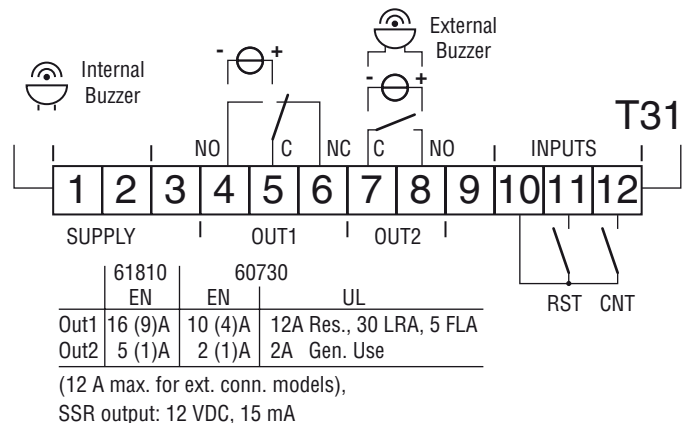

5. OPERATING MODE

5.1 Display operation

CNT LED indicates:

- Count in progress (flashing);
- Count stopped before the end (steady on);
- Count ended/Reset status (off).

After Reset display shows 0000 when counting mode is **UP** ($F_{Cnt} = uP$) or **Set time** value if the count mode is **DOWN** ($F_{Cnt} = dn$).

While counting display shows the time that elapses: increasing if $F_{Cnt} = uP$ or decreasing if $F_{Cnt} = dn$.

For functions that require a **Cycle end** ($F_{Clt} = 1, 2$) at the end of the count, the display shows: 0000 if $F_{Cnt} = dn$ or the **Set time** value if $F_{Cnt} = uP$.

At **Count end**, the **Display flashes** when parameter $EndC = 0$ or can be **Steady ON** when parameter $EndC = 1$.

5.2 Operation of the Counting commands

Counting can be enabled and disabled using the **Start/Stop** key or via the digital inputs **CNT** and **RST**.

The operating mode of the **Start/Stop** key is established by parameters L_{UFl} and i_{Fcl} , the operating mode of **CNT** input is established by i_{Fcl} parameter while the **RST** input always acts as a **Reset**, i.e. **blocks** and **resets** the count when it is activated and also has priority over the other commands (while **RST** is active, the count cannot start).

The counting **Start** signal can therefore be given by the **Start/Stop** key, which normally has bistable (toggle) operation, or via the **CNT** count enable digital input.

The operating mode of the **CNT** input can be programmed using the i_{Fcl} parameter to operate in different modes:

$i_{Fcl} = 1$ - Bistable Start/Stop

By activating the **CNT** input the count starts and it is therefore possible to deactivate the input.

Activating **CNT** again, the count stops on the value reached (without disabling the output if this was activated), the next **CNT** impulse resumes the count from the point it stopped and so on until the end of the count or the **Reset** signal.

In this mode, the front **Start/Stop** button (if $L_{UFl} = 2$) acts exactly in the same way as the **CNT** input with the addition that, when kept pressed for 2 s during the counting, carries out the **Reset** command.

If the counting is finished, pressing the key carries out the **Reset-Start** command at the same time.

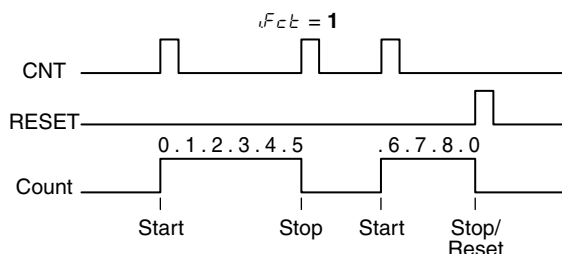

$i_{Fcl} = 2$ - Bistable Reset-Start/Stop

At the 1st impulse on the **CNT** input the timer is reset and started, at the 2nd impulse, if given before the end of the count, the count is stopped (disabling the output if active) and the 3rd impulse starts a new cycle, otherwise, if the 2nd impulse should arrive after the end of the count it starts directly a new cycle.

In this mode, the front **Start/Stop** button (if $L_{UFl} = 2$) acts in exactly the same way as the **CNT** input.

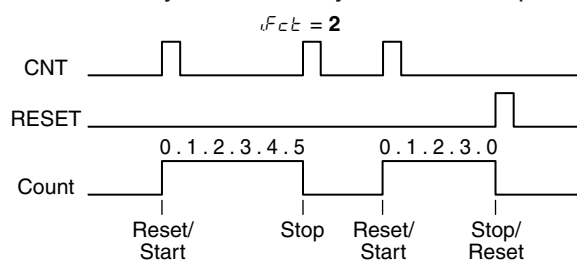

$i_{Fcl} = 3$ - Monostable Start/Stop

Activating the **CNT** input and keeping it active, the count is started; the count stops on the value reached when the input is disabled (without disabling the output if active); re-activating the **CNT** input, the count restarts from the value reached and so on until the **Reset** signal.

In this operating mode, the front **Start/Stop** key (if L_{UFl} is different from **oF**) only acts as a **Reset**.

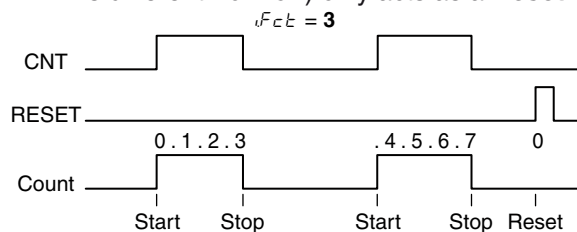

$i_{Fcl} = 4$ - Monostable Reset-Start/Stop

Activating the **CNT** input and keeping it active, the timer resets and starts counting, disabling the **CNT** input the count stops disabling the output if active.

This operating mode is similar to the one of the traditional timers in which counting is enabled when the instrument is powered while the **Reset** occurs when power supply is removed.

In this operating mode, the front **Start/Stop** key (if L_{UFl} is different from **oF**) only acts as a **Reset**.

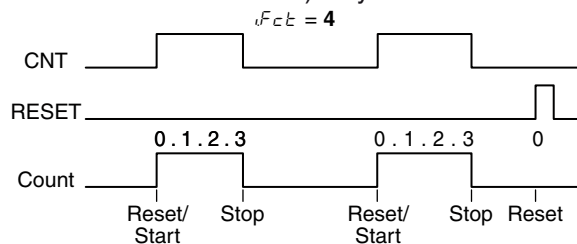

$i_{Fcl} = 5$ - Bistable Reset-Start/Stop

At 1st **CNT** impulse the timer is reset, at the 2nd the count starts, at the 3rd impulse the count stops disabling the output if active and so on.

In this mode, the front **Start/Stop** button (if $L_{UFl} = 2$) acts in exactly the same way as the **CNT** input.

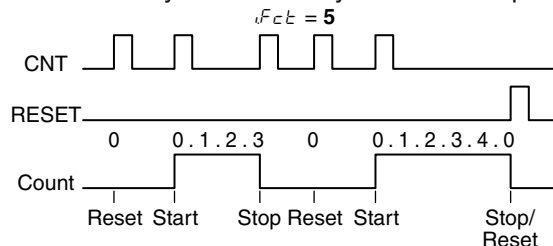

$iF_{ct} = 6$ - Bistable Start/Stop-Reset

At 1st CNT impulse the count is started, while at the 2nd impulse, if given before the end of the count, the count is stopped disabling the output if active and reset, otherwise, if the 2nd impulse should arrive after the end of the count it starts directly a new cycle.

In this mode, the front Start/Stop button (if $LF_{t} = 2$) at S_{t1} time end acts exactly in the same way as the CNT input.

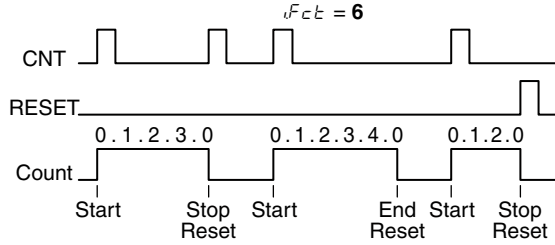

5.3 Out1 Operating mode

The Output 1 operation can be programmed in **6 different modes** with F_{o1t} parameter:

$F_{o1t} = 1$ - ON DELAY

Received the **Start** signal, instrument starts counting and, at the end of S_{t1} time, activates the **Out1** output. The output is disabled by the **Reset** signal.

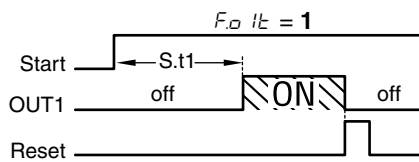

$F_{o1t} = 2$ - Feed-through

Received the **Start** signal, the instrument starts counting and activates the **Out1** output; **Out1** is disabled when S_{t1} time has elapsed. The output can be reactivated only after a **Reset** and a new **Start** signal

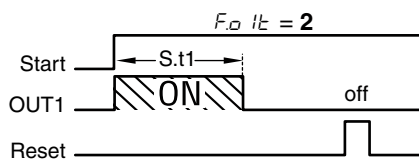

$F_{o1t} = 3$ - Asymmetrical oscillator with start ON

This operating mode requires the setting of both S_{t1} and S_{t2} Set times.

Received the **Start** signal, **Out1** is enabled for the S_{t1} time then disabled, reactivated at the end of S_{t2} time and so on until the **Stop/Reset**.

S_{t1} : **Out1 ON time**, S_{t2} : **Out1 OFF time**..

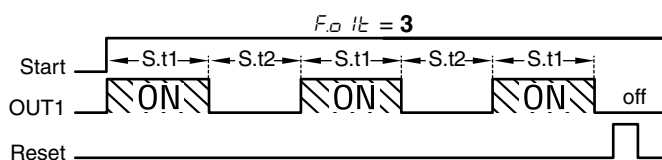

$F_{o1t} = 4$ - Asymmetrical oscillator with start OFF

This operating mode implies the setting of both S_{t1} and S_{t2} Set times.

Received the **Start** signal, **Out1** remains disabled for the S_{t1} time then is activated for the time set at S_{t2} and so on until the **Stop/Reset**.

S_{t1} : **Out1 OFF time**, S_{t2} : **Out1 ON time**.

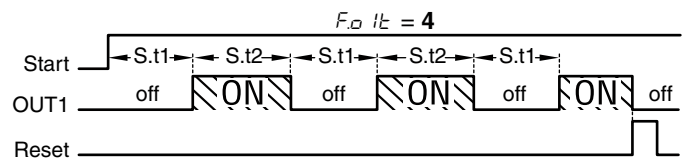

$F_{o1t} = 5$ - Asymmetrical oscillator with start OFF 1 cycle

This operating mode operates as $F_{o1t} = 4$ but executes **only 1 Start/Pause cycle**.

Received the **Start** signal, **Out1** remains disabled for the S_{t1} time then is activated for the time set at S_{t2} .

The cycle can be repeated only after a **Reset** signal and a new **Start** command.

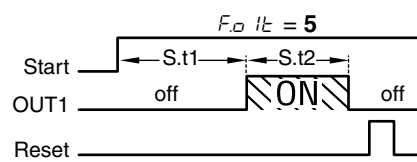

$F_{o1t} = 6$ - Delay in lack of excitation (or delay in de-excitation)

On the rising edge of the **CNT** input **Start** signal, **Out1** is energized. When the **CNT** signal is removed, **Out1** remains energized and starts the S_{t1} count elapsed which **Out1** is de-energized. If, during the S_{t1} count, a signal is detected on the **CNT** input, the time is reset and will be restarted when signal ceases.

Note: This functioning mode operates in this way regardless the iF_{ct} parameter setting. **Out2** output (if used) in this operating mode can only operate in $F_{o2t} = 1$ or 2 modes.

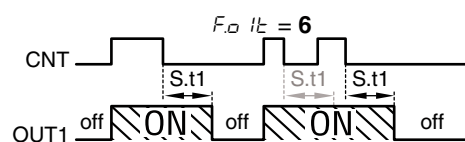

5.4 Out2 Operating mode

The Output 2 operation can be programmed in **10 different modes** with F_{o2t} parameter:

$F_{o2t} = oF$ - Out2 Output disabled

$F_{o2t} = 1$ - Out2 works like Out1

Out2 output operates exactly like **Out1** output in order to have a double output contact.

$F_{o2t} = 2$ - Out2 output works as an instant contact (ON during count)

Out2 is activated during the counting phase and remains active until the **Reset** command is received.

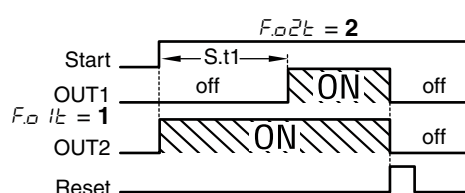

$F_{o2t} = 3$ - Out2 works as Out1 (with S_{t1} time) but with an absolute S_{t3} time

This operating mode requires the setting of S_{t1} and S_{t3} Set times. S_{t3} has the same time range and cannot be longer than S_{t1} .

Received the **Start** command, instrument starts counting and operates on **Out2** output in the same mode it operates on **Out1** (as F_{o1t}).

If $F_{o1t} = 1, 4, 5$, **Out2** operates with **ON delay** function and S_{t3} of Set time, when instead $F_{o1t} = 2, 3$ **Out2** operates with **Feed-through** function and S_{t3} of Set time.

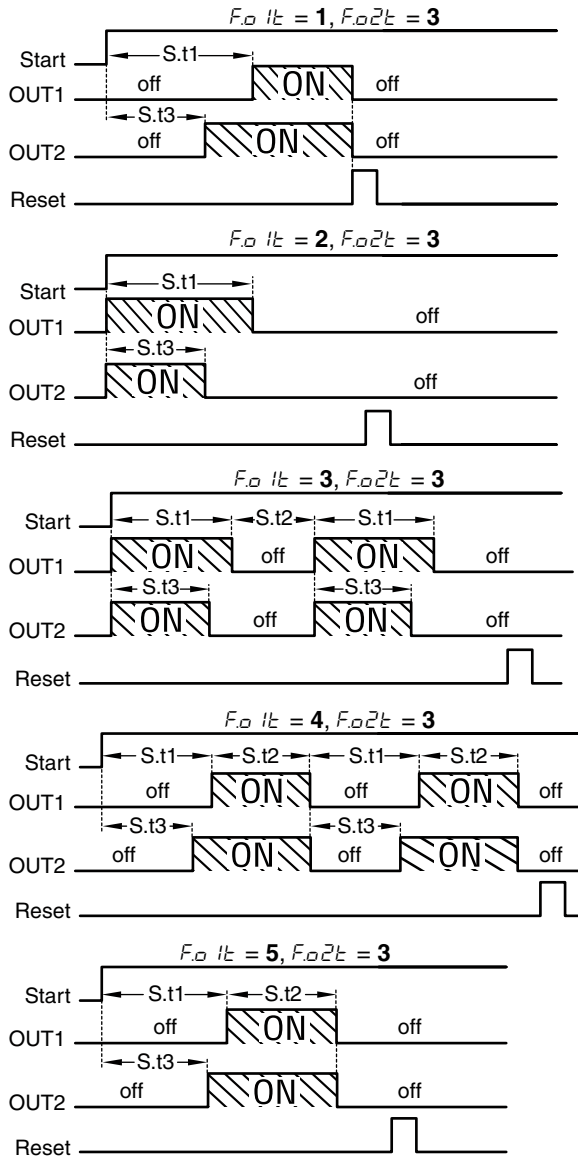

$F_{o2t} = 4$ - Out2 works as Out1 (with S_{t1} time) but with a relative S_{t3} time in advance

This operating mode requires the setting of S_{t1} and S_{t3} Set times. S_{t3} has the same time range and cannot be longer than S_{t1} .

Received the **Start** command, instrument starts counting and operates on **Out2** output in the same mode it operates on **Out1** (as F_{o1t}).

If $F_{o1t} = 1, 4, 5$, **Out2** operates with **ON delay** function and $[S_{t1} - S_{t3}]$ of Set time, when instead $F_{o1t} = 2, 3$, **Out2** operates with **Feed-through** function and $[S_{t1} - S_{t3}]$ of Set time.

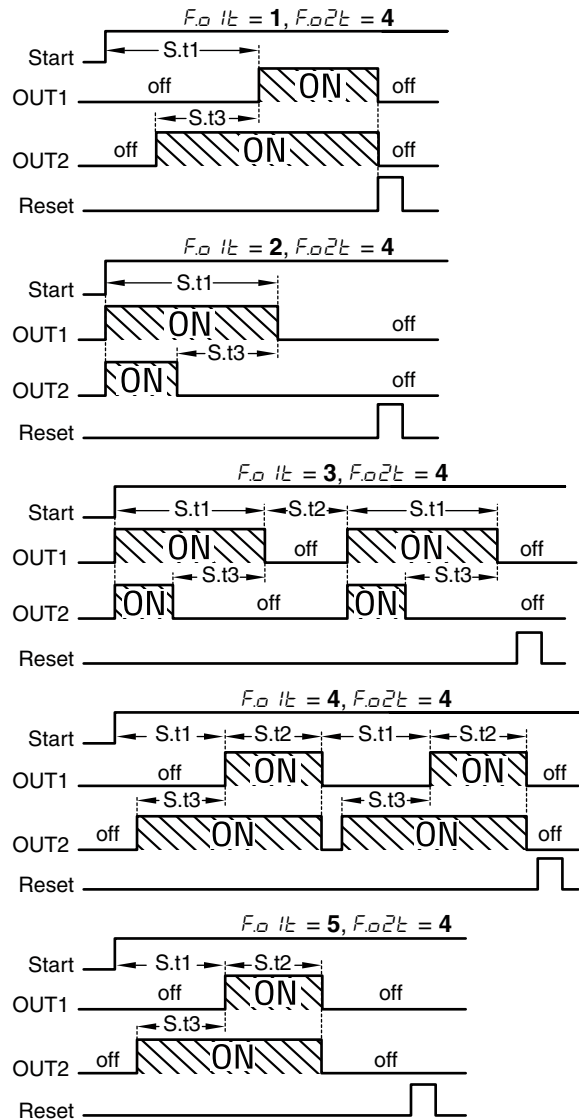

$F_{o2t} = 5$ - Out2 works as the internal buzzer with $F_{buf} = 2$

Out2 works as the internal buzzer to manage an external acoustic or luminous signalling device.

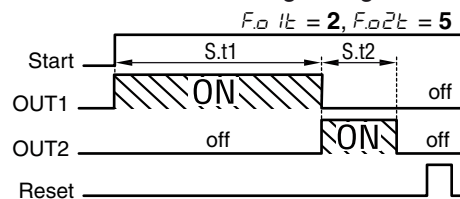

F_{o2t} = 6 - Activation at S_{t1} count end with S_{t3} delay for S_{t2} time

Out2 thus configured is activated, as for $F_{o2t} = 5$, when S_{t1} count has elapsed for the time S_{t2} but with a settable delay S_{t3} . This function is intended to be used with $F_{o1t} = 2$ only.

In this case, the display shows the t_1 time count, elapsed which it switches to display the t_3 time and then the time t_2 .

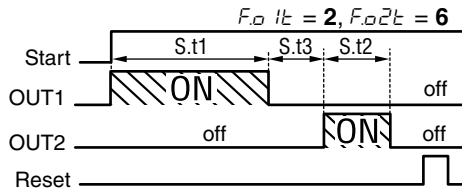

F_{o2t} = 7 - Activation at the end of S_{t1} count with delay S_{t2}

Out2 thus configured is activated when S_{t1} count has elapsed with a settable delay S_{t2} . This function is intended to be used with $F_{o1t} = 2$ only and can be used to create a **star-delta starter** where the time S_{t1} is the **Star operating time** while S_{t2} is the **Star-Delta transfer time**.

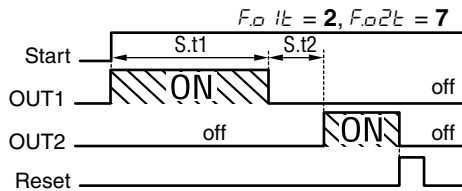

F_{o2t} = 8 - Counting operation negated with respect to Out1

Out2 output thus configured is activated, during the count, with the opposite logic to **Out1**. This function is intended to be used with $F_{o1t} = 3$ or 4 only (oscillator mode functioning) in order to obtain the alternated operation of the two outputs. In this mode the display shows the time count in progress (t_1 or t_2).

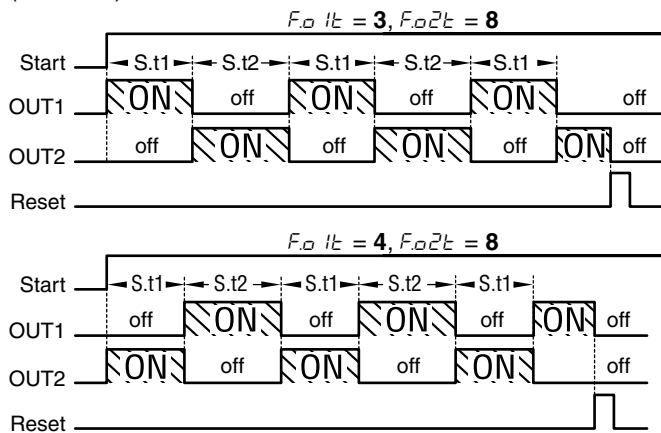

F_{o2t} = 9 - Counting operation negated with respect to Out1 but with an S_{t3} dead time

As in $F_{o2t} = 8$, while counting **Out2** output is activated with the opposite logic to **Out1**, but with an S_{t3} intermediate settable dead time.

Also in this case, this function is intended to be used with $F_{o1t} = 3$ or 4 only (oscillator mode functioning) in order to obtain the alternated operation of the two outputs, but with a dead time between the activations.

In this mode the display shows the time count in progress (t_1 , t_2 or t_3).

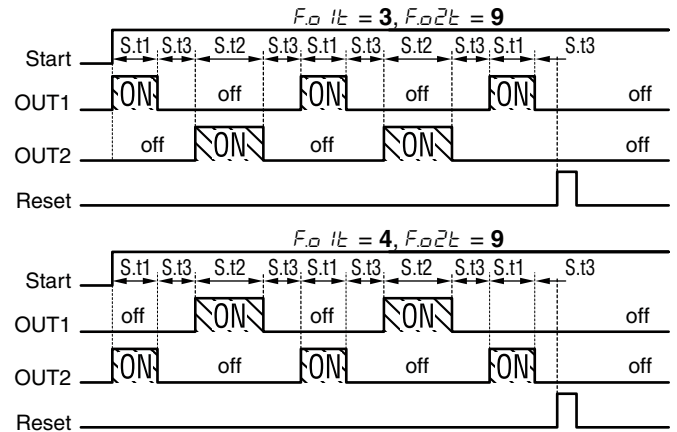

F_{o2t} = 10 - Symmetrical denied operation with respect to Out1 with dead time S_{t3}

As in $F_{o2t} = 9$ mode, while counting **Out2** output is activated with the opposite logic to **Out1**, with an S_{t3} intermediate settable dead time, but with the same active time of S_{t1} .

Also in this case, this function is intended to be used with $F_{o1t} = 3$ or 4 only (oscillator mode functioning) in order to obtain the alternated operation of the two outputs with a dead time between the activations, but with the possibility to establish the total duration of the cycle through the time S_{t2} (for example for a washing, cleaning, polishing or similar treatment cycle).

In this mode the display always shows the t_2 counting times it is the total time of the cycle.

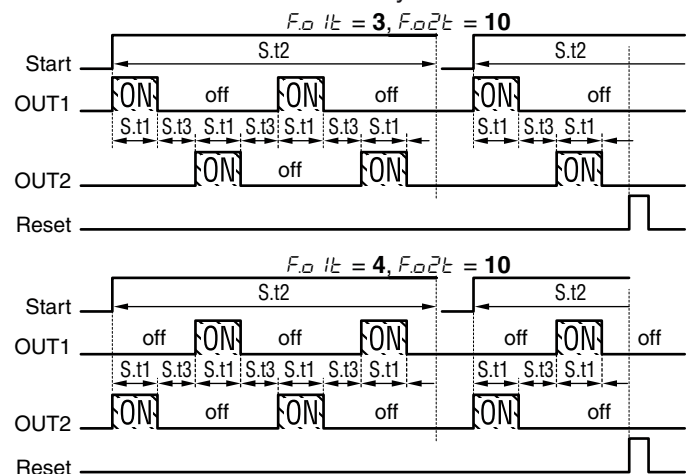

5.5 Internal buzzer operation

The internal buzzer can be programmed using the F_{buF} parameter to operate in the following ways:

oF Internal buzzer disabled;

1. Activated at end of S_{t1} time for S_{t2} period; sound also when keys are pressed. If **Reset** command is given (with key or digital input), the buzzer is silenced immediately. This mode is only active for operations that normally do not involve the use of the S_{t2} time (this is because S_{t2} is used in work-pause operations that would not have substantially a determined cycle end);
2. Activated at S_{t1} end for S_{t2} time; no sound when keys are pressed;
3. Sounds when keys are pressed;
4. Only external buzzer (if configured on **Out2** with $F_{out} = 5$) with operation at the end of **S.t1** time for a period of S_{t2} .

5.6 Operation in case of power supply failure (backup)

F_{buF} parameter establishes the count behavior when power supply returns after a power supply failure during the current count:

1. Resets the count;
2. Stops the count by storing the value reached (when the power returns, it therefore waits for a command to restart);
3. Stores the reached value and, when the power returns, the count restarts from that value if the conditions for restarting are present (e.g. the instrument was counting with a bistable command when the power was lost).

6. ACCESSORIES

The instrument is equipped with a 5-pole connector which can be used to link some external accessories that allow to perform some functions in “off-line” mode.

6.1 Parameters configuration with A01

The instrument is equipped with a 5 poles connector that allows the transfer from and toward the instrument of the functioning parameters through the device **A01**.



A01 is mainly usable for the **serial programming** of some **instruments** which need to **have the same parameters configuration** or to **keep a copy of the parameters setting** of an instrument and allow its rapid retransmission.

The same device allows to **connect a PC** via USB with which, through the “*AT UniversalConfig*” configuration software the operating parameters can be configured.

To use the device **A01** it is necessary that **the device or instrument** are being **powered directly or through the key**.

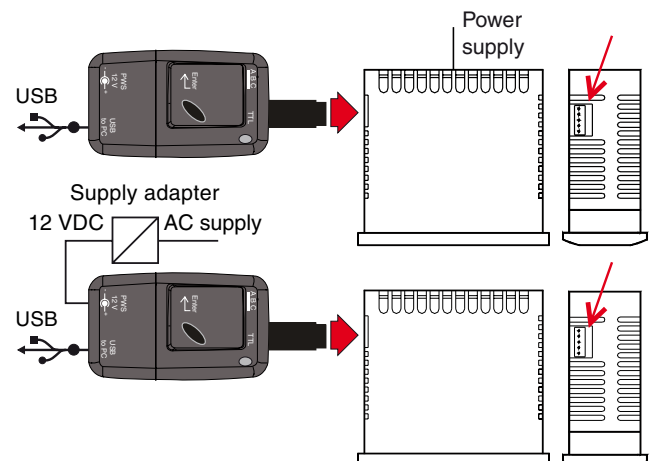

For additional info, please read the “*A01 Instruction Manual*”.

6.2 Parameters configuration with AFC1

When the instrument is equipped with the **NFC** communication option, the parameter configuration performed with the “*AT UniversalConfig*” program (see previous paragraph) can be transferred to the instrument also through the **AFC1** device or a smartphone equipped with the **NFC** interface and the dedicated **App AT Conf.**



To configure the instrument with the **NFC**, it is not necessary to power the timer, but simply put its front panel on the symbol (☺) of the **AFC1** device (which is powered directly by the **USB** port connected to the **PC**) or on the smartphone part on the which is the **NFC** interface (for this consult the smartphone user manual) then send the parameters to the instrument's memory.

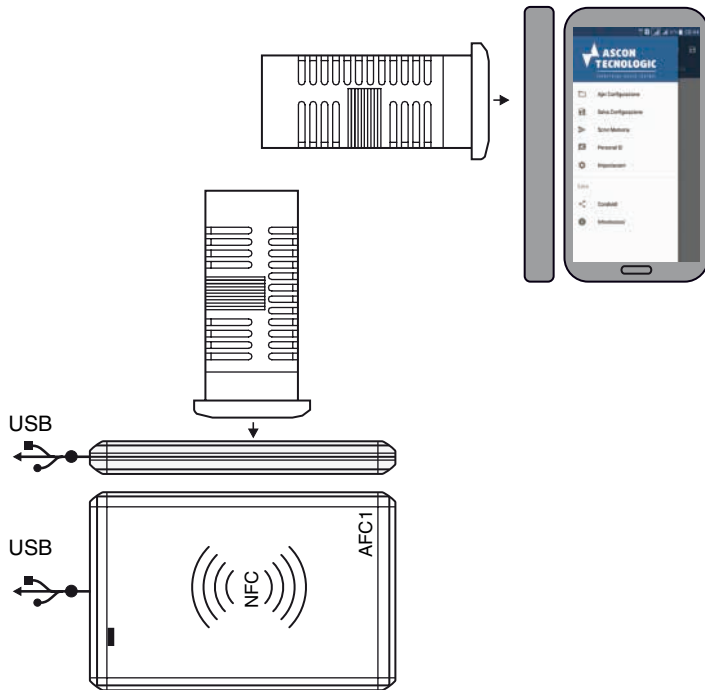

7. PROGRAMMABLE PARAMETERS TABLE

Here below is a description of all the parameters available on the instrument. Some of them may not be present, either due to the fact they depend on the type of instrument or because they are automatically disabled as unnecessary.

Parameter	Description	Range	Default	Note
1	S_{Lt1} S_{t1} min. Set time	0 ÷ S.Ht1	0	
2	S_{Ht1} S_{t1} max. Set time	S.Lt1 ÷ 9999	99.59	
3	S_{Lt2} S_{t2} min. Set time	0 ÷ S.Ht2	0.00	
4	S_{Ht2} S_{t2} max. Set time	S.Lt2 ÷ 9999	99.59	
5	S_{St1} S_{t1} Time range	1 Hours (9999 h); 2 Hours - Minutes (99 h 59 min); 3 Minutes - Seconds (99 min 59 s); 4 Seconds - Hundreds of seconds (99 s 99 1/100 s).	3	
6	S_{St2} S_{t2} Time range		3	
7	S_{t1} S_{t1} Set time	S.Lt1 ÷ S.Ht1	1.00	
8	S_{t2} S_{t2} Set time	S.Lt2 ÷ S.Ht2	0.00	
9	S_{t3} S_{t3} Set time	S.Lt1 ÷ S.Ht1	0.00	
10	F_{Cnt} CNT input operating mode	1 Bistable START/STOP; 2 Bistable RESET-START/STOP; 3 Monostable START/STOP; 4 Monostable RESET-START/STOP; 5 Bistable RESET/START/STOP; 6 Bistable START/STOP-RESET.	2	
11	F_{o1t} OUT1 output operating mode	1 On delay; 2 Feed-through; 3 Asymmetrical oscillator with start ON; 4 Asymmetrical oscillator with start OFF; 5 Asymmetrical oscillator with start OFF (one cycle only); 6 Delay in lack of excitation (or delay in de-excitation).	1	
12	F_{o2t} OUT2 output operating mode	oF No function; 1 Out2 operates as Out1; 2 Instantaneous Contact Output (ON during count); 3 Out2 operates as Out1 but with absolute Set time S_{t3} ; 4 Out2 operates as Out1 but with relative Set time S_{t3} in advance; 5 Out2 operates as the buzzer; 6 Activation at S_{t1} count end with S_{t3} delay for S_{t2} time; 7 Activation at S_{t1} count end with S_{t2} delay; 8 Counting operation negated with respect to Out1; 9 Counting operation negated with respect to Out1 but with an S_{t3} dead time; 10 Symmetrical denied operation with respect to Out1 with S_{t3} dead time.	oF	
13	F_{Cnt} Count mode	uP UP; dn DOWN.	uP	
14	F_{buF} Buzzer operating mode	oF Disable; 1 Sounds at end of the cycle for the S_{t2} period + key pressure; 2 Sounds at end of the cycle for the S_{t2} period; 3 Key pressure sound only; 4 External buzzer only (if configured on Output 2 with $F_{o2t} = 5$) with end of the cycle for the S_{t2} period	1	
15	t_{UFL} START/STOP button operating mode	oF No function 1 RESET only 2 RESET-START/STOP if $F_{Cnt} = 1 / 2$, or RESET/START/STOP if $F_{Cnt} = 5 / 6$	2	
16	t_{Edt} Times visibility with Fast Set time procedure (P key)	oF No Set time visibility; 1 S_{t1} ; 2 S_{t2} ; 3 S_{t1} and S_{t2} ; 4 S_{t3} ; 5 S_{t1} and S_{t3} ; 6 S_{t2} and S_{t3} ; 7 S_{t1} , S_{t2} and S_{t3} ; 8 S_{t1} only directly with ▲ / ▼ keys with no P key pressure.	1	
17	F_{buT} Backup operation mode	1 Resets the current count; 2 Stops the current count storing the value reached; 3 Stores the reached value and when the power returns, it restarts from that value if the conditions for restarting are present.	1	
18	E_{ndC} Display flashing at count end	0 Display flashing at count end; 1 Display steady ON at count end.	0	
19	r_{out} Output relay exchange	1-2 Operation F_{o1t} with Out1 ; F_{o2t} with Out2 ; 2-1 Operation F_{o1t} with Out2 ; F_{o2t} with Out1 .	0	
20	t_{Lo} Keyboard lock	oF Lock disabled; 1 ÷ 9999 s	oF	
21	t_{PP} Password parameters protection	oF Password disabled; 1 ÷ 9999	oF	

8. PROBLEMS AND MAINTENANCE

8.1 Cleaning

It is recommended to clean the instrument only with a cloth wetted with water or with a detergent neither abrasive nor containing solvents.

8.2 Disposal

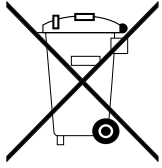

The appliance (or the product) must be disposed of separately in compliance with the local standards in force on waste disposal.

9. WARRANTY AND REPAIRS

The instrument is under warranty against construction vices or defected material, noticed within 18 months from delivery date. The warranty is limited to the repairs or to the substitution of the instrument. The eventual opening of the housing, the violation of the instrument or the wrong use and installation of the product means the automatic decay of the warranty. In case of defected instrument, noticed in warranty period or out of warranty, do contact our sales department to obtain the shipment authorisation.

The defected product must be shipped to Ascon Tecnologic with the detailed description of the failures found and without any fees or charge for Ascon Tecnologic, safe different agreements.

10. TECHNICAL DATA

10.1 Electrical data

Power supply: 12 VAC/VDC, 24 VAC/VDC, 100 ÷ 240 VAC ±10%;

AC frequency: 50/60 Hz;

Power consumption: About 3 VA;

Inputs: 2 free of voltage **digital inputs**;

Outputs: Up to **2 relay outputs** or **12 VDC/15 mA for SSR drive**;

	EN 61810	EN 60730	UL 60730
Out1 - SPDT - 16A - 1HP 250V, 1/2HP 125 VAC	16 (9) A	10 (4) A	12 A Res., 30 LRA, 5 FLA
Out2 - SPST-NO - 5A - 1/10HP 125/250V	5 (1) A	2 (1) A	2 A Gen. Use

12 A max. for those with removable terminal model;

Relay output Electrical life: 100000 operations;

Overvoltage category: II;

Protection class: Class II;

Insulation: Reinforced insulation between low voltage parts (H or L type power supply and relay outputs) and front panel; Reinforced insulation between low voltage parts (H or L type power supply and outputs if both are relays) and the extra low voltage parts (inputs); Reinforced insulation between power supply and relay outputs; Basic insulation between relay outputs and between relay and SSR drive output; Basic insulation between H or L type power supply and inputs when a relay + SSR drive output combination is present; No insulation between type F power supply terminals and input.

10.2 Mechanical characteristics

Housing: Self-extinguishing plastic, UL 94 V0;

Heat and fire resistance category: D;

Ball Pressure Test as described in EN60730: accessible parts 75°C; support live parts 125°C;

Dimensions: 78 x 35 mm, depth 64 mm;

Weight: About 125 g;

Mounting: Incorporated flush in panel (thickness max. 12/29 mm) in a 71 x 29 mm hole;

Connections:

Inputs: Fixed or removable screw terminal block for 0.2 ÷ 2.5 mm²/AWG 24 ÷ 14 cables;

Power supply: Fixed or removable screw terminal block or Faston 6.3 mm for 0.2 ÷ 2.5 mm²/AWG 24 ÷ 14 cables;

Protection degree: IP65 mounted with screw type bracket (optional);

Pollution degree: 2;

Operating temperature: 0 ÷ 50°C;

Operating humidity: < 95 RH% with no condensation;

Storage temperature: -25 ÷ +60°C.

10.3 Functional features

Time range: 4 programmable timing scales:

9999 h,

99 h 59 min,

99 min 59 s,

99 s 99 hundreds of second;

Display resolution: Based on the time scale used:

hours,

minutes,

seconds,

hundreds of second;

Overall accuracy: ±0.1 fs;

Input delay: 15 ms max.;

Display: 4 Digit Red (Blue optional), height 12 mm;

Compliance:

Directive LV 2014/35/EU (EN 60730-1, EN 60730-2-7, EN61812-1, UL 508);

Directive EMC 2014/30/EU (EN55011: class B; EN61000-4-2: 8 kV air, 4 kV cont.; EN61000-4-3: 10V/m; EN61000-4-4: 2 kV supply and relay outputs, 1 kV inputs; EN61000-4-5: supply 2 kV com. mode, 1 kV\diff. mode; EN61000-4-6: 3V).

11.HOW TO ORDER

MODEL

T31 - = Timer with mechanical keyboard

a: NFC PROGRAMMING OPTION

- = Not present
- N** = With NFC programming option

b: POWER SUPPLY

- H** = 100... 240 VAC
- L** = 24 VAC/VDC
- F** = 12 VAC/VDC

c: OUTPUT 1 (OUT 1)

- S** = Relay SPDT 16A-AC1 (for resistive loads)
- O** = 12 VDC for SSR

d: OUTPUT 2 (OUT 2)

- R** = Relay SPST 5A-AC1 (for resistive loads)
- O** = 12 VDC for SSR or Buzzer
- = Not present

e: INTERNAL BUZZER

- B** = Buzzer
- = Not present

f: POWER SUPPLY AND OUTPUT TERMINALS

- V** = Screw terminals (standard)
- E** = Complete removable screw terminals (pitch 5.00)
- N** = Removable screw terminals (pitch 5.00)
- F** = Faston 6.3 mm

g: INPUT TERMINALS

- V** = Screw terminals (standard)
- E** = Complete removable screw terminals (pitch 5.00)
- N** = Removable screw terminals (pitch 5.00)

h: DISPLAY

- R** = Red (standard)
- U** = Blue

i: FRONT PANEL COLOUR

- A** = Black
- W** = White

j: PACKAGING + BRACKET TYPE

- B** = AT package + "Butterfly" type brackets (standard)
- D** = AT package + screw type bracket

k - **a** **b** **c** **d** **e** **f** **g** **h** **i** **j** **k** **ll** **mm**

k: RESERVED CODE;

ll, mm: Hardware/Software personalization

---- (standard)

